



T&S BRASS AND BRONZE WORKS, INC.
 2 Saddleback Cove / P.O. Box 1088
 Travelers Rest, SC 29690

Model No.
MV-2516-33

Item No.

Travelers Rest, SC: 800-476-4103 • Simi Valley, CA: 800-423-0150 • Fax: 864-834-3518 • www.tsbrass.com

This Space for Architect/Engineer Approval

Job Name _____ Date _____

Model Specified _____ Quantity _____

Customer/Wholesaler _____

Contractor _____

Architect/Engineer _____

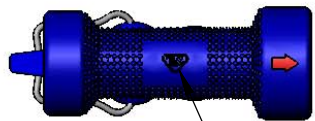

T&S Logo on Top

Ø 2 5/16"
 [Ø 59mm]

Ø 7/16"
 Flow Orifice

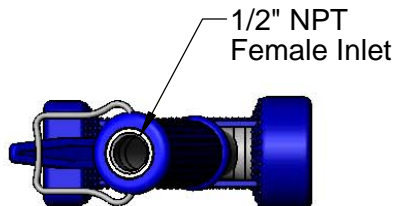
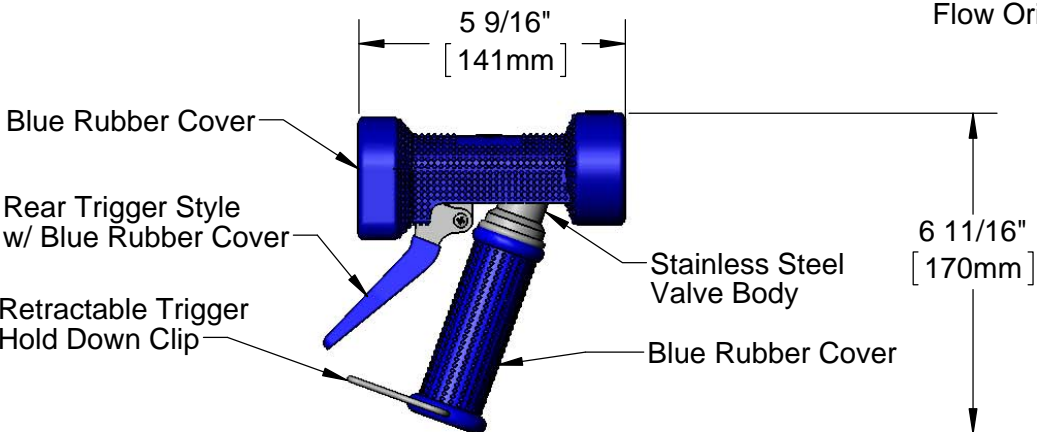

1/2" NPT
 Female Inlet



1/2" NPT x 1"
 Hose Barb Connector
 (Included)

Product Specifications:
 Stainless Steel Water Gun w/ Blue Rubber Cover, Rear Style Trigger,
 Ø 7/16" Flow Orifice & 1/2" NPT x 1" Hose Barb Connector

Product Compliance:
 NSF 61 Exempt (Non-Potable)