



**ADA Compliant**

*This Space for Architect/Engineer Approval*

Job Name \_\_\_\_\_ Date \_\_\_\_\_

Model Specified \_\_\_\_\_ Quantity \_\_\_\_\_

Customer/Wholesaler \_\_\_\_\_

Contractor \_\_\_\_\_

Architect/Engineer \_\_\_\_\_

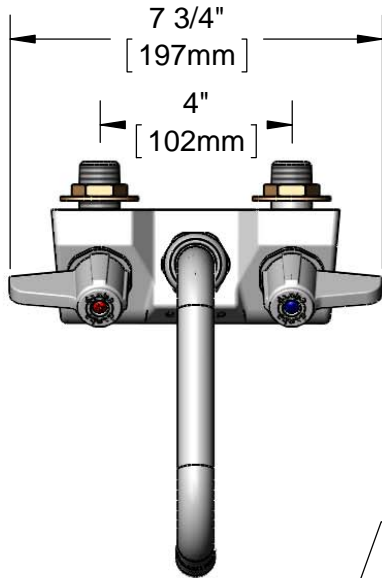

5SP-06A  
equip 6" Swing Nozzle  
w/ 2.2 GPM Aerator.  
Rigid Conversion Requires  
014200-45 Lock Washer  
(Sold Separately)

Ceramic Cartridges &  
Lever Handles w/ Color  
Coded Screws

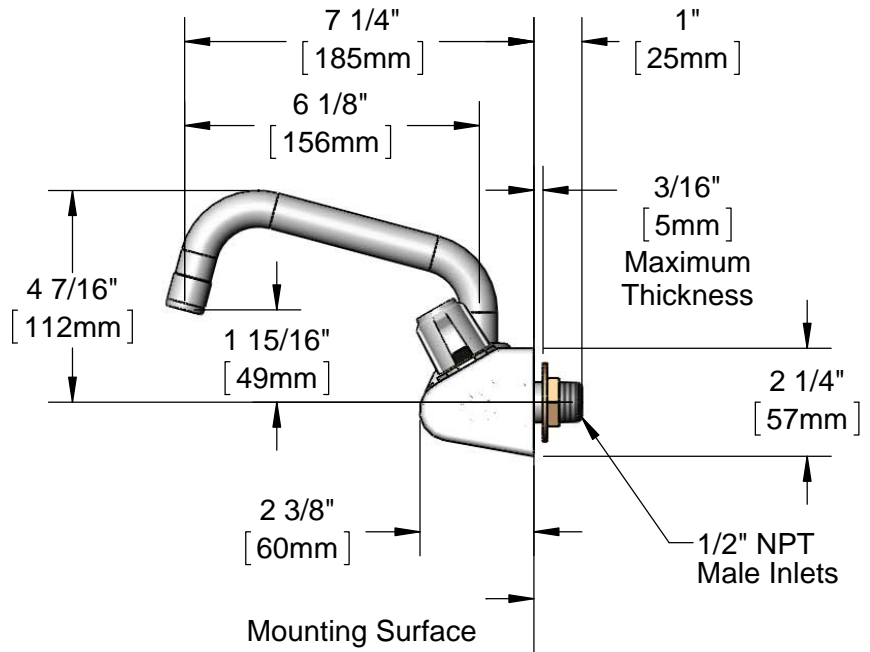
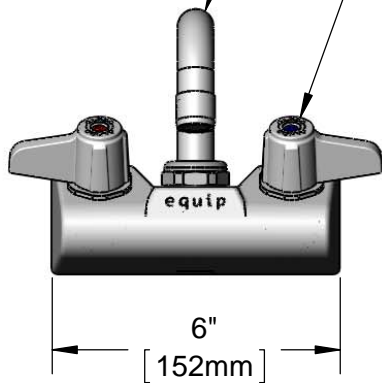

**Rough-In Requirement:**  
(2) Ø 1" [25mm] Mounting Holes

Model Number 5F-4WLX06	Date 06/05/12	Scale 1:4	Drawn DHL	Checked DMH	Approved JHB
---------------------------	------------------	--------------	--------------	----------------	-----------------



Product Specifications:  
4" Wall Mount Mixing Faucet w/ Ceramic Cartridges, equip Lever  
Handles, equip 6" Swing Nozzle w/ 2.2 GPM Aerator &  
1/2" NPT Male Inlets

equip Foodservice Accessories  
2 Saddleback Cove, P.O. Box 1088  
Travelers Rest, South Carolina 29690  
Phone: 800.891.4808 Fax: 800.868.0084

ITEM NO.	SALES NO.	DESCRIPTION
1	5SP-06A	equip 6" Swing Nozzle
2	013838-45	Aerator, 3/4-27 Female, 2.2 GPM
3	013839-25	equip Swivel Nut
4	013848-45	equip Swivel Piece O-ring
5	017587-45	Swivel Nut Seal
6	5-HDL-L	equip Lever Handle w/ Color Coded Screws
7	013788-25	equip Ceramic Cartridge, LTC
8	000999-45	Brass Lock Washer
9	002954-45	Shank Lock Nut
10	013787-25	equip Ceramic Cartridge, RTC

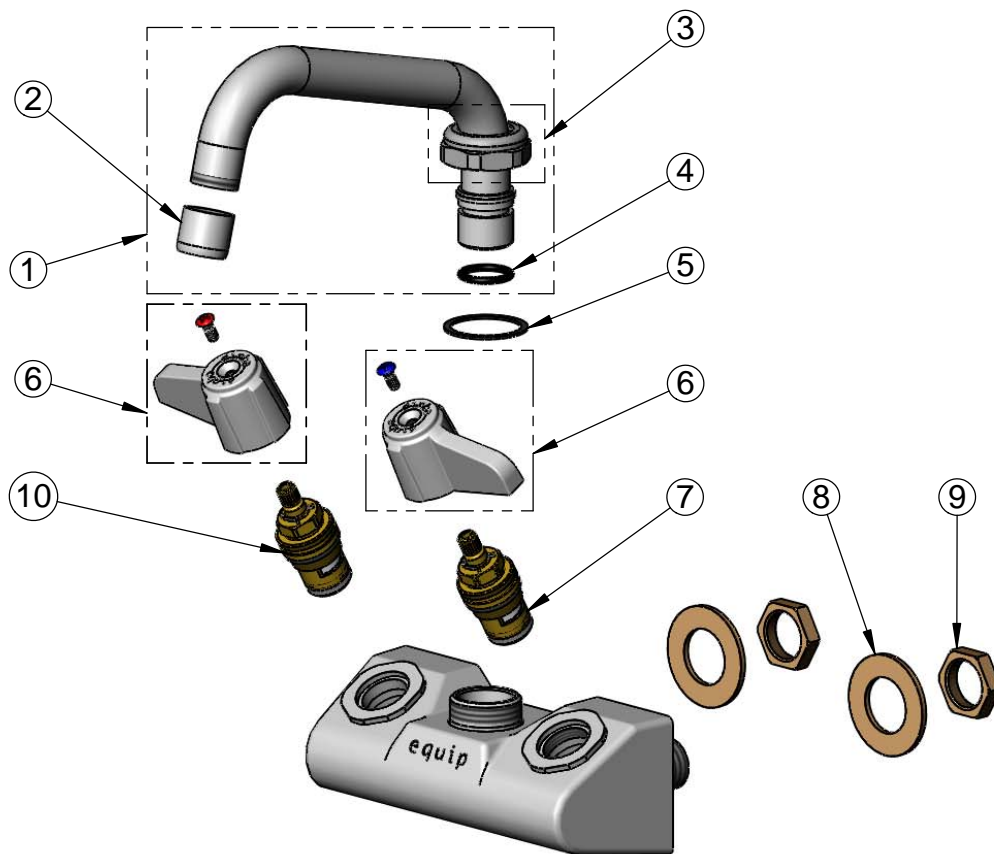

Model Number 5F-4WLX06	Date 06/05/12	Scale NTS	Drawn DHL	Checked DMH	Approved JHB
---------------------------	------------------	--------------	--------------	----------------	-----------------



Product Specifications:  
4" Wall Mount Mixing Faucet w/ Ceramic Cartridges, equip Lever Handles, equip 6" Swing Nozzle w/ 2.2 GPM Aerator & 1/2" NPT Male Inlets

equip Foodservice Accessories  
2 Saddleback Cove, P.O. Box 1088  
Travelers Rest, South Carolina 29690  
Phone: 800.891.4808 Fax: 800.868.0084