



ADA Compliant

This Space for Architect/Engineer Approval

Job Name _____ Date _____

Model Specified _____ Quantity _____

Customer/Wholesaler _____

Contractor _____

Architect/Engineer _____

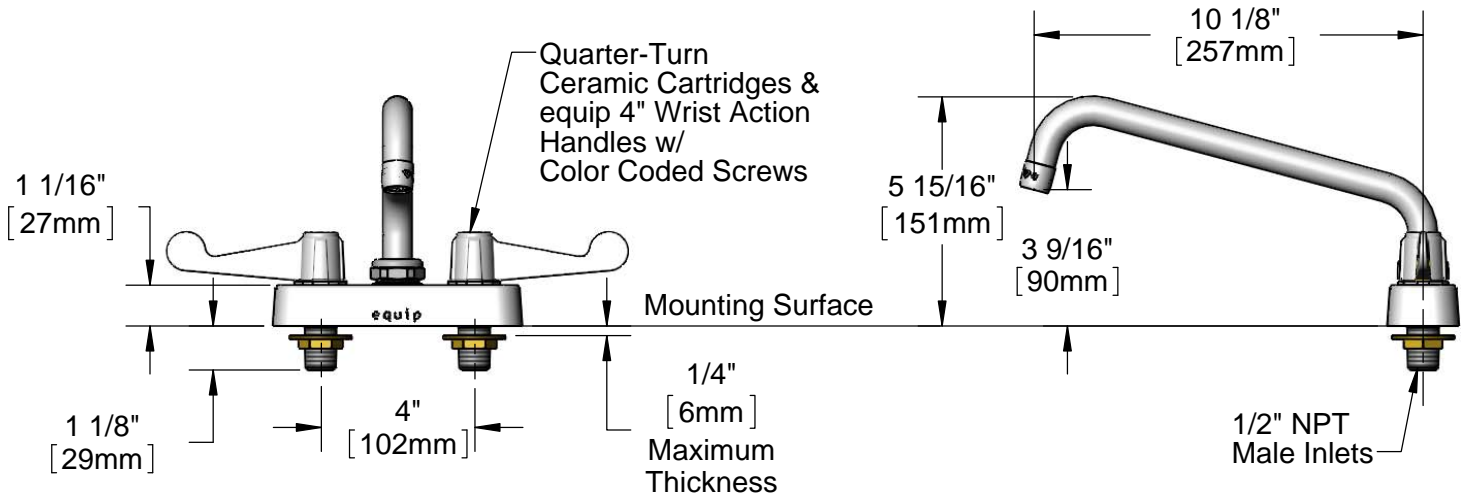
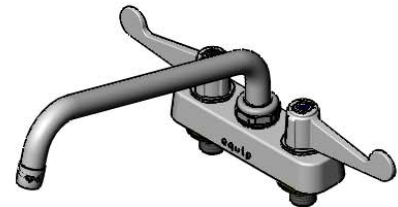
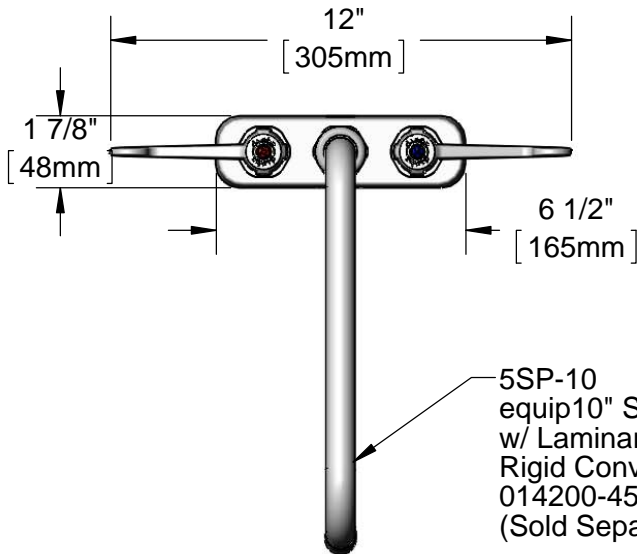

Rough-In Requirement:
(2) Ø 1" [25mm] Mounting Holes

Model Number

5F-4CWX10

Product Specifications:

4" Deck Mount Workboard Mixing Faucet w/ Quarter-Turn Ceramic Cartridges, equip 4" Wrist Action Handles, equip 10" Swing Nozzle & 1/2" NPT Male Inlets

Product Compliance:

ASME A112.18.1 / CSA B125.1
NSF 61 - Section 9
NSF 372 (Low Lead Content)
ANSI A117.1 (ADA)

equip
Foodservice
Accessories

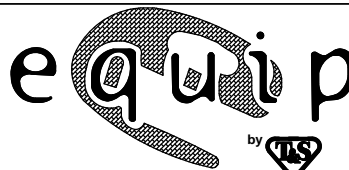

2 Saddleback Cove, P.O. Box 1088
Travelers Rest, South Carolina 29690
Phone: 800.891.4808 Fax: 800.868.0084
equip.tsbrass.com

ITEM NO.	SALES NO.	DESCRIPTION
1	5SP-10	equip 10" Swing Nozzle
2	014250-45	Laminar Flow Device
3	013839-25	equip Swivel Nut
4	013848-45	equip Swivel Piece O-Ring
5	5-HDL-W	equip 4" Wrist Action Handle w/ Color Coded Screws
6	013788-25	equip Ceramic Cartridge, LTC
7	000999-45	Brass Lock Washer
8	002954-45	Shank Lock Nut
9	017587-45	Swivel Nut Seal
10	013787-25	equip Ceramic Cartridge, RTC

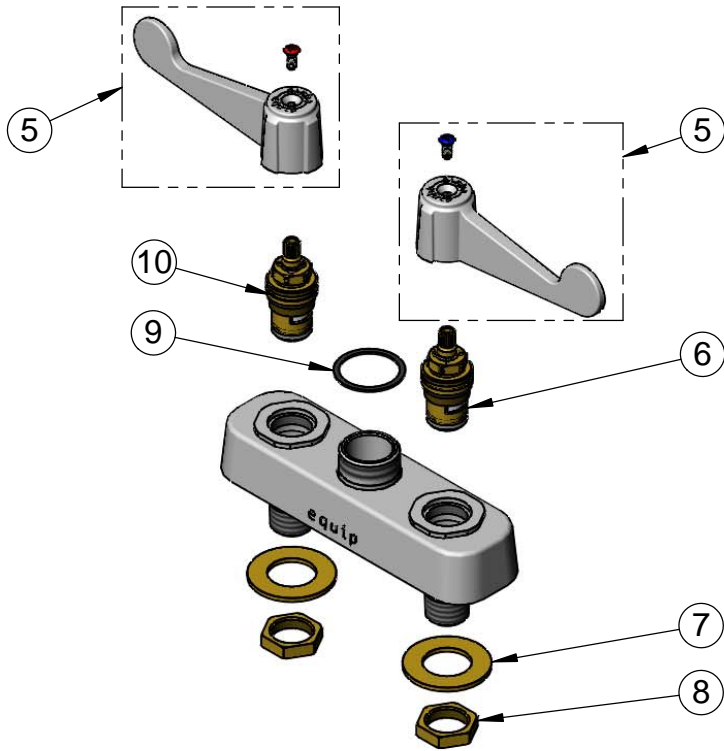
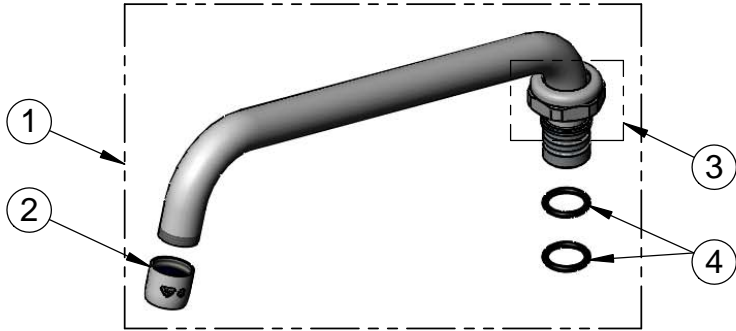

Model Number

5F-4CW10

Product Specifications:

4" Deck Mount Workboard Mixing Faucet w/ Quarter-Turn Ceramic Cartridges, equip 4" Wrist Action Handles, equip 10" Swing Nozzle & 1/2" NPT Male Inlets

Product Compliance:

ASME A112.18.1 / CSA B125.1
NSF 61 - Section 9
NSF 372 (Low Lead Content)
ANSI A117.1 (ADA)

equip
Foodservice
Accessories

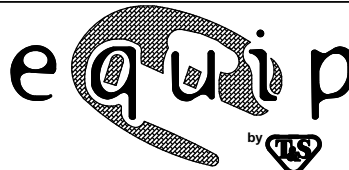

2 Saddleback Cove, P.O. Box 1088
Travelers Rest, South Carolina 29690
Phone: 800.891.4808 Fax: 800.868.0084
equip.tsbrass.com