



T&S BRASS AND BRONZE WORKS, INC.

2 Saddleback Cove / P.O. Box 1088
Travelers Rest, SC 29690

Model No.

EC-3102-SMT8

Item No.

Travelers Rest, SC: 800-476-4103 • Simi Valley, CA: 800-423-0150 • Fax: 864-834-3518 • www.tsbrass.com



ADA Compliant

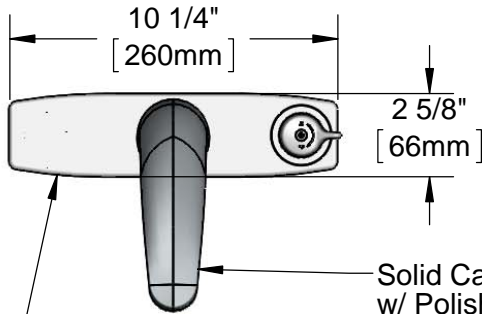

Chrome Plated Die Cast Deck Plate

Solid Cast Brass Spout w/ Polish Chrome Plated Finish and 016355-45, 2.2 GPM [8.3L/min] Vandal Resistant Aerator

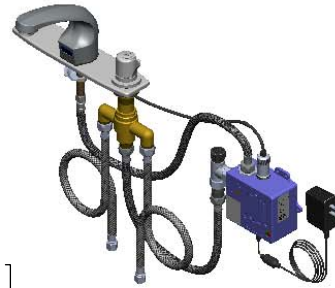

This Space for Architect/Engineer Approval

Job Name _____ Date _____

Model Specified _____ Quantity _____

Customer/Wholesaler _____

Contractor _____

Architect/Engineer _____

3 5/8" x 4 3/16" x 2" Deep [92mm x 106mm x 51mm] Water Resistant Control Module Box (Blue) w/ Internal Flow Control Setting Switches, AC or DC Operated w/ (4) AA Batteries. Hardwire Capable Using Terminals on Back

EC-SMT Above Deck Side Mount Adjustable Thermostatic Mixing Valve w/ Check Valves

4" [102mm]

1/2" NPSM x 1/4" NPSM 18" [457mm] Flexible Stainless Steel Hose

Removable Strainer

24" [610mm] Sensor Cable

2 7/16" [62mm]

Mounting Surface

4 7/8" [124mm]

4 3/8" [111mm]

5 3/8" [137mm]

7/8" [22mm] Maximum Thickness

100-240 VAC Adapter w/ 71" [1800mm] Power Cord. (Remove Rubber Plugs on Module and Cable to Connect)

VR Aerator Key (Included) 

VR Screw L-Key (Included) 

Shank Nut Wrench (Included) 

1/2" NPSM x 1/2" NPSM 16" [406mm] Flexible Stainless Steel Hose

(2) 3/8" Compression x 1/2" NPSM 18" [457mm] Flexible Stainless Steel Supply Hose

Rough-In Requirement:
(2) ϕ 1" [25mm] Mounting Holes

Product Specifications:

Chrome Plated Brass Electronic Faucet: Single Hole Deck Mount Spout w/ 8" Centers Deck Plate, Above Deck Side Mount Adjustable Thermostatic Mixing Valve w/ Check Valves, AC/DC Control Module with Internal Flow Control Setting Switches, 18" Hot & Cold Supply Stop Flexible Connector Hoses

Product Compliance:

ASME A112.18.1 / CSA B125.1
NSF 61 - Section 9
NSF 372 (Low Lead Content)
ANSI A117.1 (ADA)
UL 1951
ASSE 1070 (TMV)



T&S BRASS AND BRONZE WORKS, INC.

2 Saddleback Cove / P.O. Box 1088
Travelers Rest, SC 29690

Model No.

EC-3102-SMT8

Item No.

Travelers Rest, SC: 800-476-4103 • Simi Valley, CA: 800-423-0150 • Fax: 864-834-3518 • www.tsbrass.com

ITEM NO.	SALES NO.	DESCRIPTION
1	B-0199-08	VR 2.2 GPM Aerator, 13/16-27 UN Male w/ Key
2	017195-45	Angled Sensor w/ Cable
3	018251-45	ChekPoint 8" C-C SMT Deck Plate
4	018541-45	M4 x 20mm, SS, Torx VR FH Screw
5	018249-45	Handle
6	018248-45	Temperature Limit Stop
7	EC-SMT	Above Deck Thermostatic Mixing Valve w/ Handle
8	016297-45	Inlet Hose, Faucet, 1/2" NPSM-F x 1/4" NPSM-F
9	016647-45	ChekPoint Module (Blue)
10	EC-FILTER	Replacement Filter
11	002534-25	Close Nipple, 1/2" NPT
12	5EF-0002	Plug-in AC Transformer
13	016167-45	Supply Hose, 1/2" NPSM Female x 1/2" NPSM Female
14	5EF-0005	Supply Hose, 9/16-24 Female x 1/2" NPSM

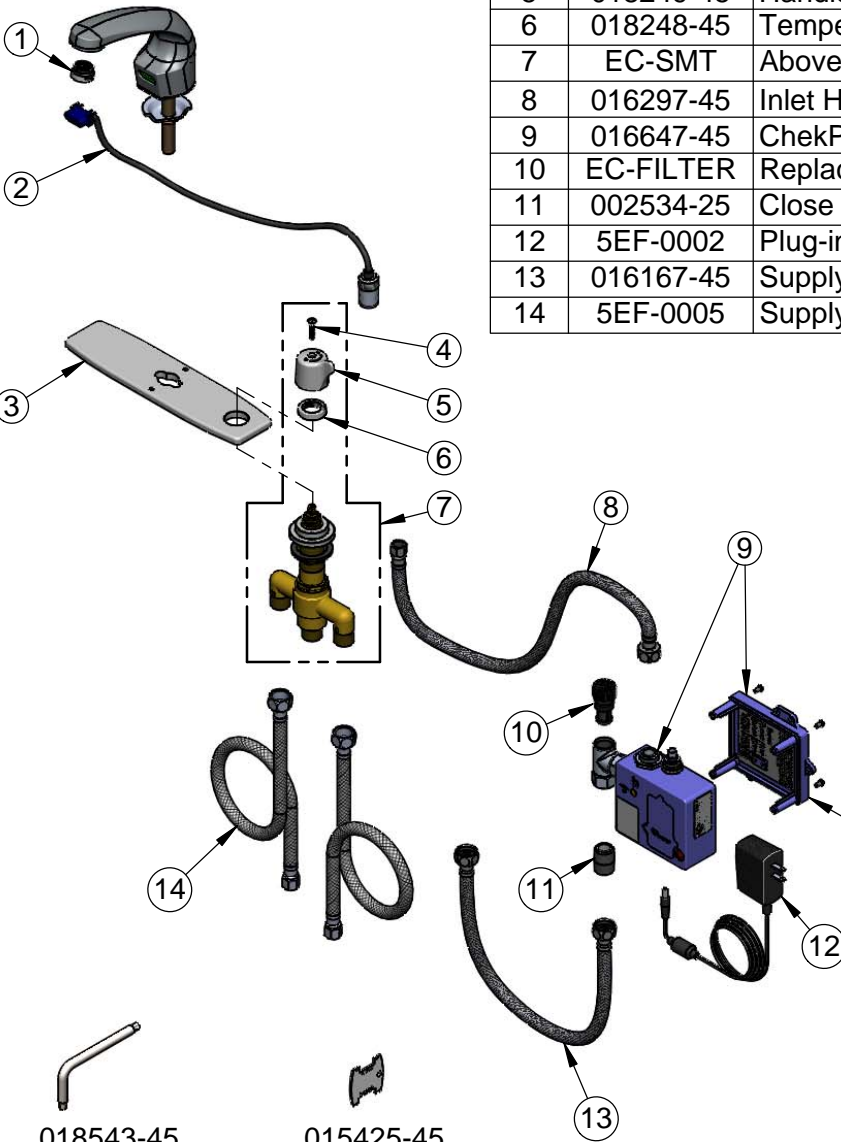

A Maximum of (8) ChekPoint Faucets can be Hardwire Connected and Powered by EC-HARDWIRE ChekPoint Hardwire AC Transformer. (Sold Separately)

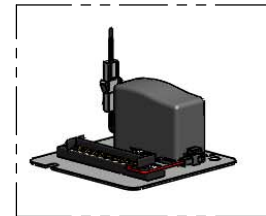

Label for Flow Control Switch Settings is Located on Inside of Back Cover.

Flow Control Switches are Located Inside Module Housing in Black Box Next to Battery Compartment.
*Switches are Set to DEFAULT Position:
- Auto Time Out = 15 Seconds
- Shut Off Delay = 1 Second
- Auto Flush = OFF

Remove (4) Screws and Back Cover to Access Switches.

*Available Water Flow Control Selections:

- Auto Time Out: 15 sec, 30 sec, 45 sec, 60 sec, 3 min, 20 min
- Shut Off Delay: 1 sec, 10 sec, 15 sec, 30 sec
- Auto Flush (30 Seconds After Every 12 Inactive Hours): ON or OFF

Product Specifications:

Chrome Plated Brass Electronic Faucet: Single Hole Deck Mount Spout w/ 8" Centers Deck Plate, Above Deck Side Mount Adjustable Thermostatic Mixing Valve w/ Check Valves, AC/DC Control Module with Internal Flow Control Setting Switches, 18" Hot & Cold Supply Stop Flexible Connector Hoses

Product Compliance:

ASME A112.18.1 / CSA B125.1
NSF 61 - Section 9
NSF 372 (Low Lead Content)
ANSI A117.1 (ADA)
UL 1951
ASSE 1070 (TMV)