



T&S BRASS AND BRONZE WORKS, INC.

2 Saddleback Cove / P.O. Box 1088
Travelers Rest, SC 29690

Model No.

BF-0299-18

Item No.

Travelers Rest, SC: 800-476-4103 • Simi Valley, CA: 800-423-0150 • Fax: 864-834-3518 • www.tsbrass.com



ADA Compliant

This Space for Architect/Engineer Approval

Job Name _____ Date _____

Model Specified _____ Quantity _____

Customer/Wholesaler _____

Contractor _____

Architect/Engineer _____

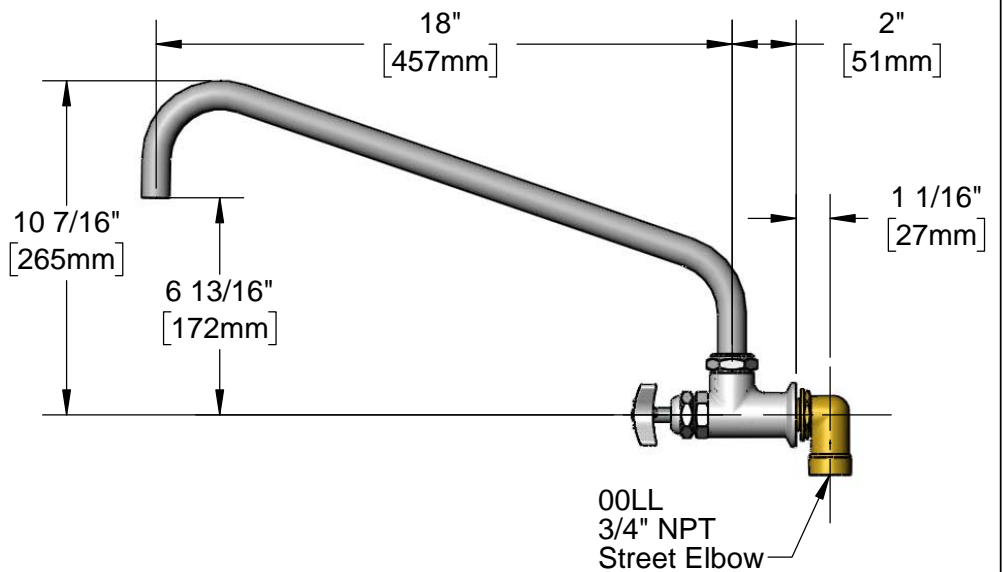
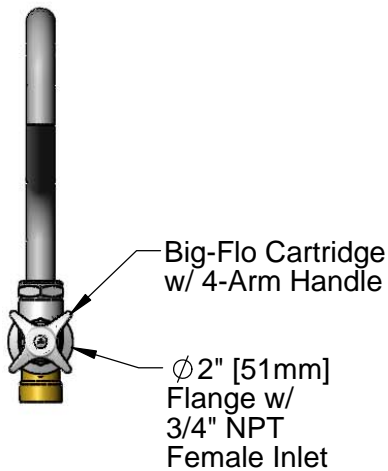
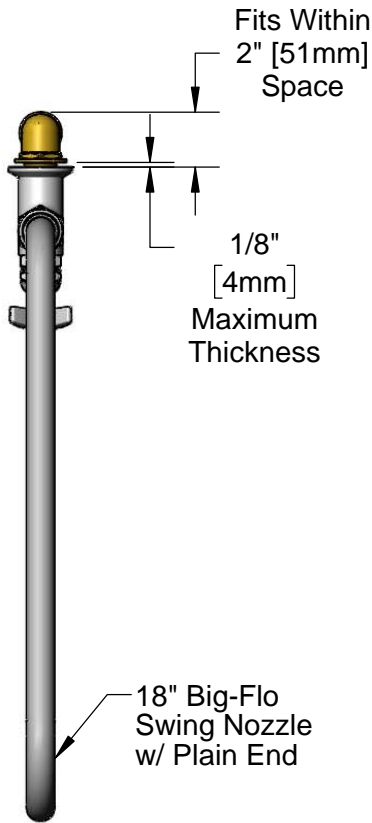

Rough-In Requirement:
Ø1 1/4" [32mm] Hole

Product Specifications:
Single Wall Mount Big-Flo Faucet w/ Big-Flo cartridge, 18" Plain End
Swing Nozzle, 4-Arm Handle & 3/4" Street Elbow

Product Compliance:
ASME A112.18.1 / CSA B125.1
NSF 61 - Section 9
NSF 372 (Low Lead Content)
ANSI A117.1 (ADA)



T&S BRASS AND BRONZE WORKS, INC.
 2 Saddleback Cove / P.O. Box 1088
 Travelers Rest, SC 29690

Model No.
BF-0299-18

Item No.

Travelers Rest, SC: 800-476-4103 • Simi Valley, CA: 800-423-0150 • Fax: 864-834-3518 • www.tsbrass.com

ITEM NO.	SALES NO.	DESCRIPTION
1	115X	18" Big-Flo Swing Nozzle
2	001068-45	O-ring
3	000922-45	Lever Handle Screw
4	002521-45	4-Arm Handle
5	006482-40	Big-Flo Cartridge, RTC
6	000764-20	Seat, Big-Flo
7	00LL	3/4" Street Elbow Inlet

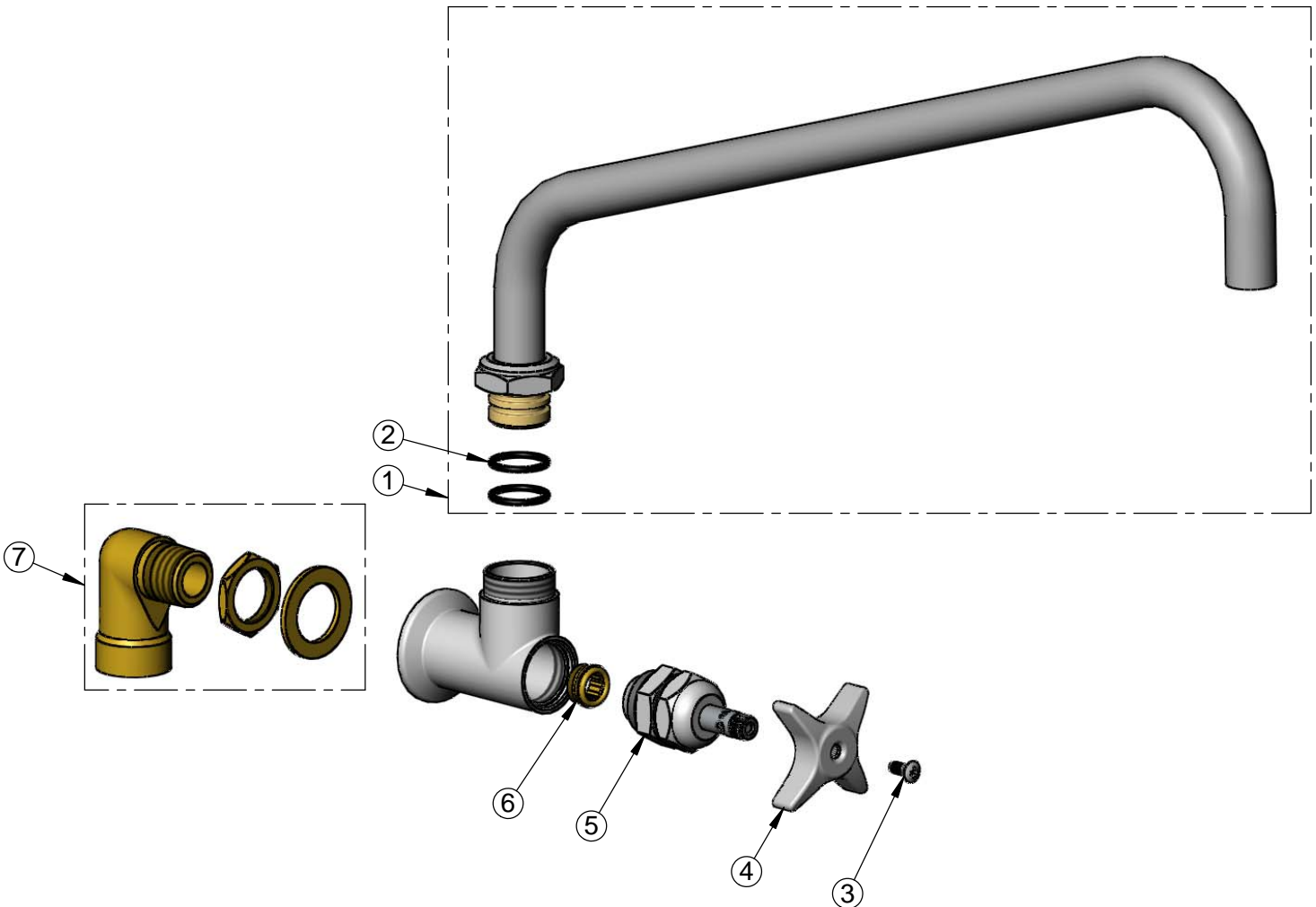

Product Specifications:
 Single Wall Mount Big-Flo Faucet w/ Big-Flo cartridge, 18" Plain End Swing Nozzle, 4-Arm Handle & 3/4" Street Elbow

Product Compliance:
 ASME A112.18.1 / CSA B125.1
 NSF 61 - Section 9
 NSF 372 (Low Lead Content)
 ANSI A117.1 (ADA)