



T&S BRASS AND BRONZE WORKS, INC.

2 Saddleback Cove / P.O. Box 1088
Travelers Rest, SC 29690

Model No.

BF-0299-10

Item No.

Travelers Rest, SC: 800-476-4103 • Simi Valley, CA: 800-423-0150 • Fax: 864-834-3518 • www.tsbrass.com

This Space for Architect/Engineer Approval

Job Name _____ Date _____

Model Specified _____ Quantity _____

Customer/Wholesaler _____

Contractor _____

Architect/Engineer _____



ADA Compliant

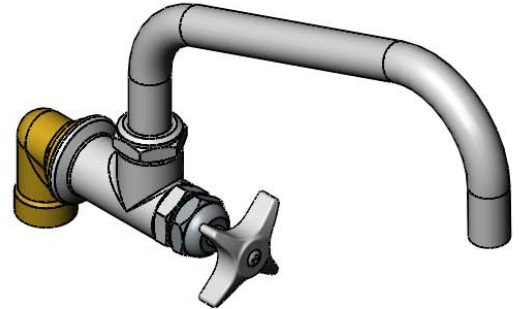

1/8"
[4mm]
Maximum
Thickness

Mounting
Surface

Fits Within
2" [51mm]
Space

10"
[254mm]

10" Big-Flo Swing Nozzle
w/ Plain End

Ø2" [51mm]
Flange w/
3/4" NPT
Female Inlet

4-Arm Handle

7 11/16"
[195mm]

4"
[102mm]

1 13/16"
[46mm]

00LL
3/4" NPT
Street Elbow

2"
[51mm]

1 1/16"
[27mm]

Rough-In Requirement:
Ø1 1/4" [32mm] Hole

Product Specifications:

Single Wall Mount Big-Flo Faucet w/ 10" Plain End Swing Nozzle,
4-Arm Handle & 3/4" Street Elbow

Drawn

DMH

Checked

JRM

Approved

JHB

Scale:

1:4

Date:

10/18/12



T&S BRASS AND BRONZE WORKS, INC.
 2 Saddleback Cove / P.O. Box 1088
 Travelers Rest, SC 29690

Model No.
BF-0299-10

Item No.

Travelers Rest, SC: 800-476-4103 • Simi Valley, CA: 800-423-0150 • Fax: 864-834-3518 • www.tsbrass.com

ITEM NO.	SALES NO.	DESCRIPTION
1	112X	10" Big-Flo Swing Nozzle
2	001068-45	O-ring
3	000922-45	Lever Handle Screw
4	002521-45	4-Arm Handle
5	006482-40	Big-Flo Cartridge, RTC
6	000764-20	Seat, Big-Flo
7	00LL	3/4" Street Elbow Inlet

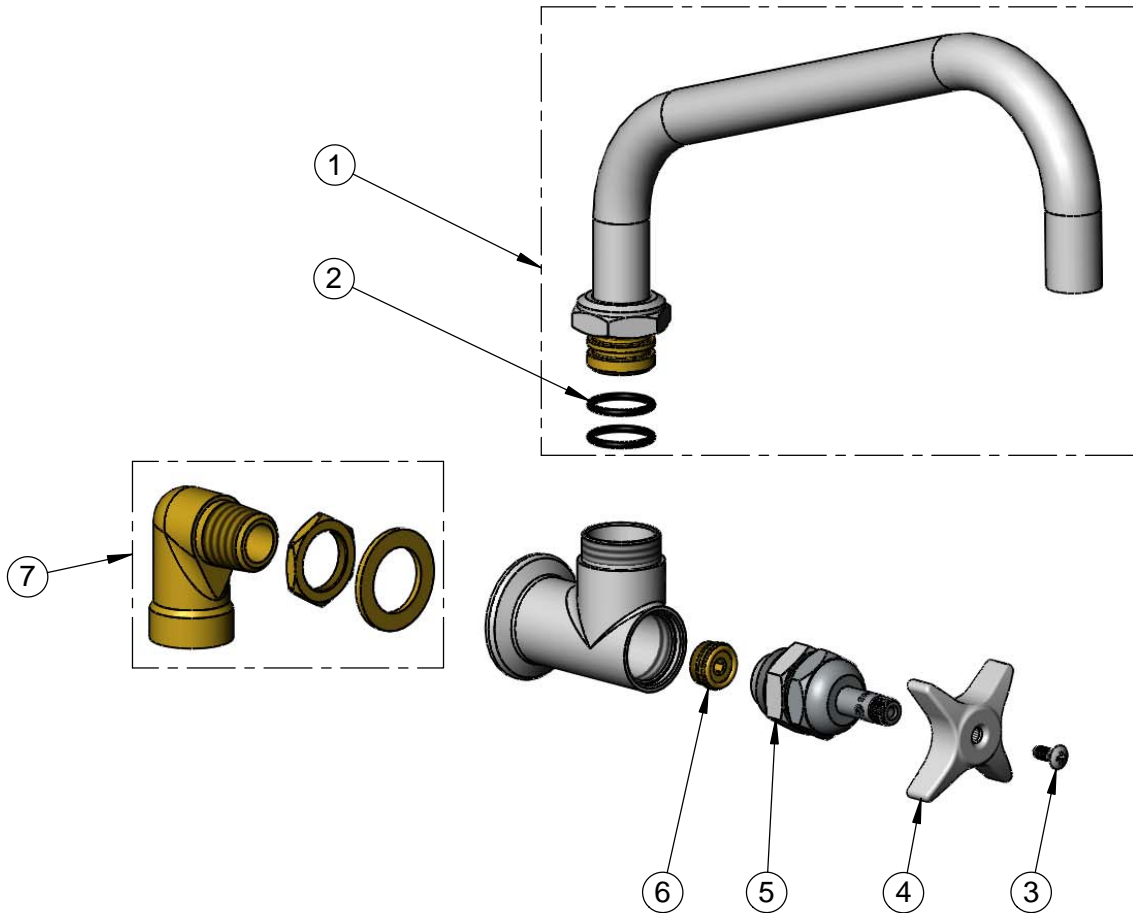

Product Specifications:
 Single Wall Mount Big-Flo Faucet w/ 10" Plain End Swing Nozzle,
 4-Arm Handle & 3/4" Street Elbow

Drawn DMH	Checked JRM	Approved JHB
Scale: NTS		Date: 10/18/12