



T&S BRASS AND BRONZE WORKS, INC.
 2 Saddleback Cove / P.O. Box 1088
 Travelers Rest, SC 29690

Model No.
B-7143-03

Item No.

Travelers Rest, SC: 800-476-4103 • Simi Valley, CA: 800-423-0150 • Fax: 864-834-3518 • www.tsbrass.com

This Space for Architect/Engineer Approval

Job Name _____ Date _____

Model Specified _____ Quantity _____

Customer/Wholesaler _____

Contractor _____

Architect/Engineer _____

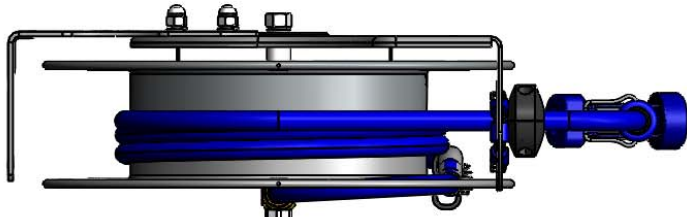

1/2" NPT Female Inlet
 (Left Side of Reel)

Open Stainless Steel Hose Reel
 50' of 1/2" Hose

Ø 19 5/8"
 [498mm]

9 7/16"
 [240mm]

20 9/16"
 [523mm]

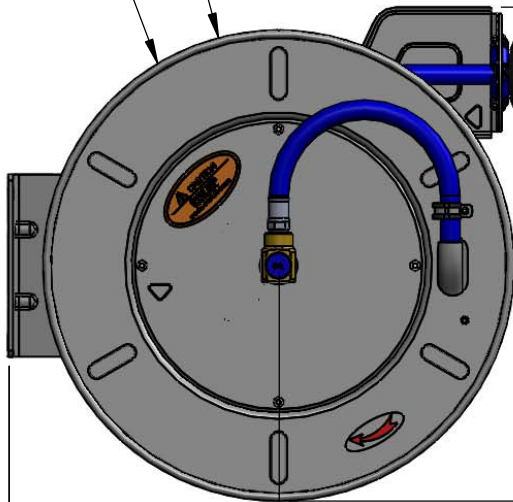
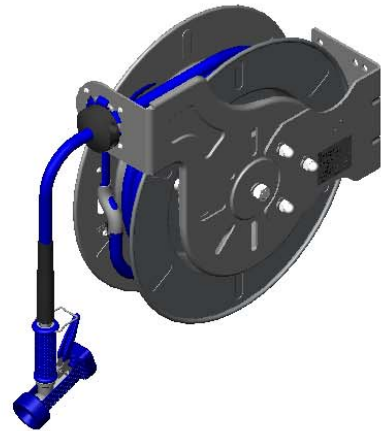

11 1/4"
 [286mm]

21 1/16"
 [535mm]

MV-2516-34
 Stainless Steel Rear Trigger
 Water Gun, 7/16" Orifice

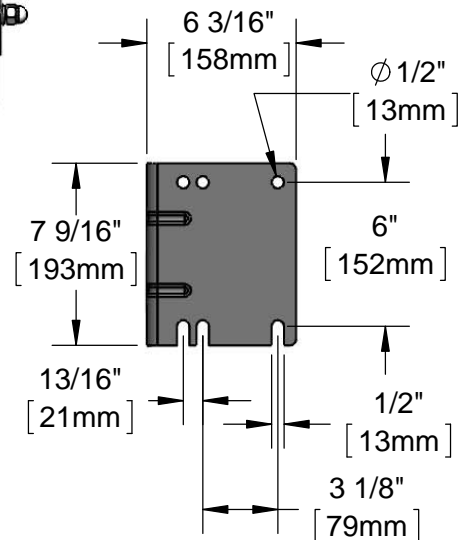
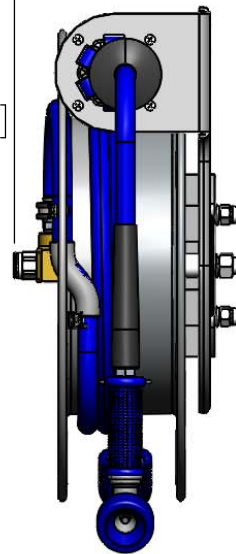

Product Specifications:

1/2" x 50' Open Stainless Steel Reel w/ Stainless Steel Rear Trigger
 Water Gun with Rubber Cover, 7/16" Flow Orifice and 1/2" NPT Female Inlet

Product Compliance:

NSF 61 Exempt (Non-Potable)



T&S BRASS AND BRONZE WORKS, INC.
 2 Saddleback Cove / P.O. Box 1088
 Travelers Rest, SC 29690

Model No.
B-7143-03

Item No.

Travelers Rest, SC: 800-476-4103 • Simi Valley, CA: 800-423-0150 • Fax: 864-834-3518 • www.tsbrass.com

ITEM NO.	SALES NO.	DESCRIPTION
1	MV-2516-34	Stainless Steel Rear Trigger Water Gun w/ Blue Rubber Cover, 7/16" Flow Orifice
2	014945-45	1/2" x 50' Hose Replacement Kit
3	019499-45	1/2" Hose Stop Repair Kit
4	014947-45	1/2" Swivel Repair Kit
5	019473-45	O-Ring Replacement Kit
6	014935-45	Large Stainless Steel Spring
7	014938-45	Roller Replacement Kit
8	014940-45	Ratchet Repair Kit

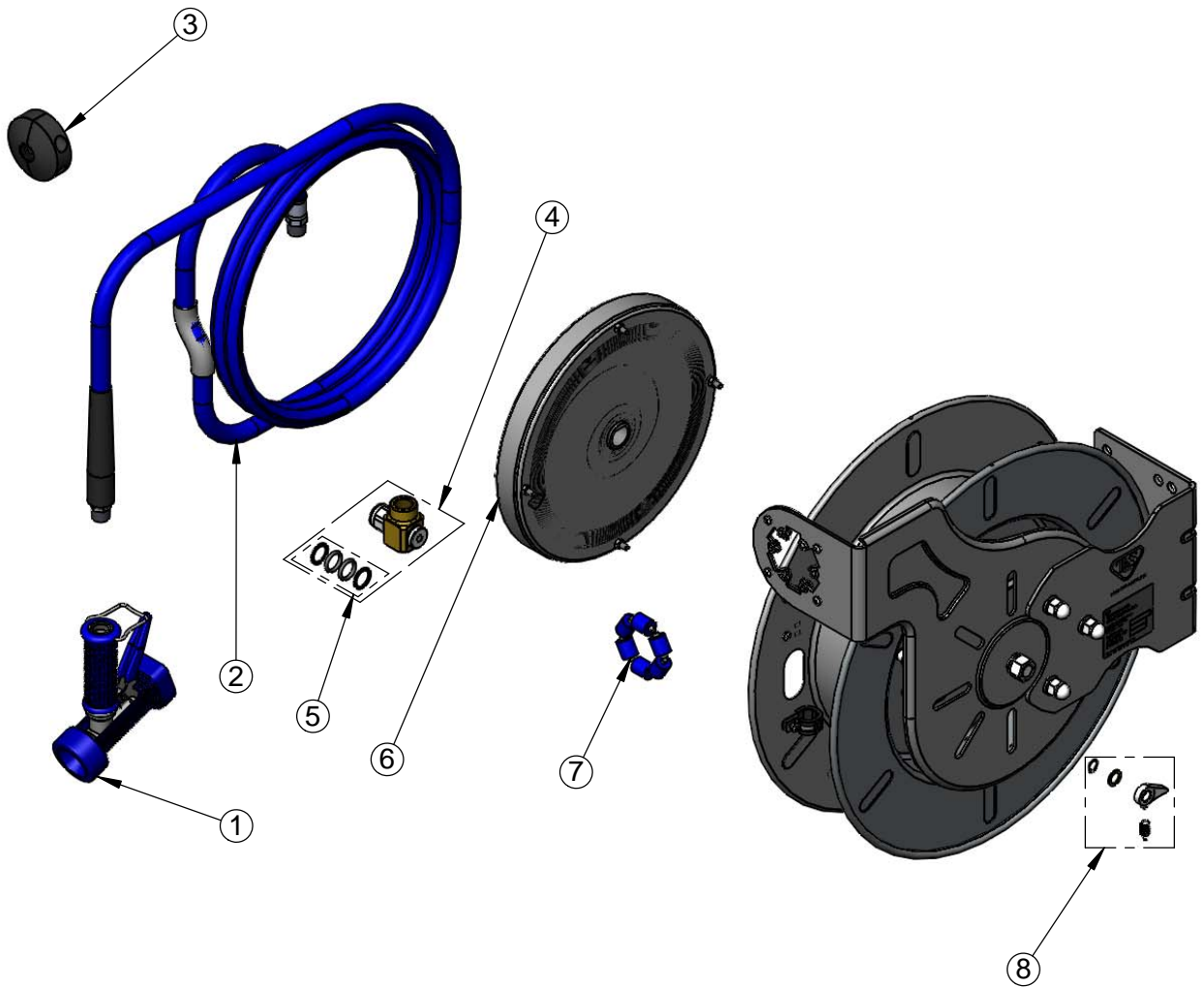

Product Specifications:
 1/2" x 50' Open Stainless Steel Reel w/ Stainless Steel Rear Trigger Water Gun with Rubber Cover, 7/16" Flow Orifice and 1/2" NPT Female Inlet

Product Compliance:
 NSF 61 Exempt (Non-Potable)