



T&S BRASS AND BRONZE WORKS, INC.

2 Saddleback Cove / P.O. Box 1088
Travelers Rest, SC 29690

Model No.

B-0221-CC

Item No.

Travelers Rest, SC: 800-476-4103 • Simi Valley, CA: 800-423-0150 • Fax: 864-834-3518 • www.tsbrass.com



ADA Compliant

This Space for Architect/Engineer Approval

Job Name _____ Date _____

Model Specified _____ Quantity _____

Customer/Wholesaler _____

Contractor _____

Architect/Engineer _____

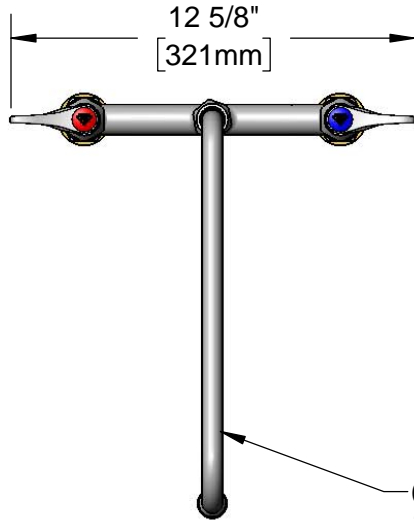

062X
12" Swing Nozzle w/
Stream Regulator Outlet.
Converts to Rigid w/
014200-45 Lock Washer
(Included)

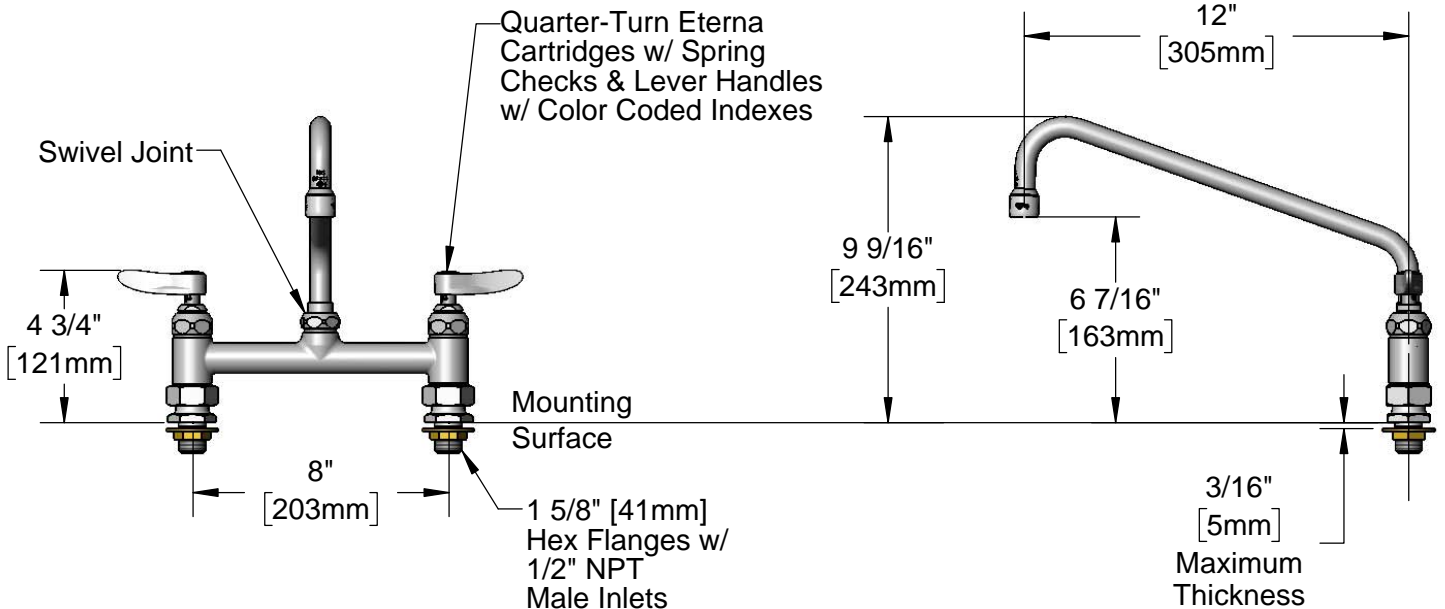
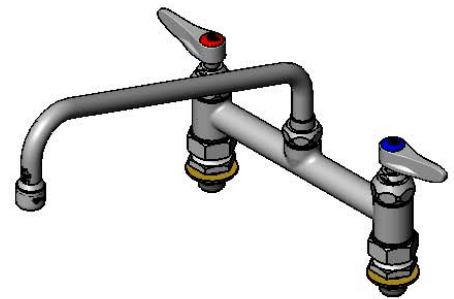

Rough-In Requirement:
(2) ϕ 1" [25mm] Mounting Holes

Product Specifications:
8" Deck Mount Mixing Faucet, Quarter-Turn Eterna Cartridges w/ Spring Checks, Lever Handles, 12" Swing Nozzle & 1/2" NPT Male Inlets

Product Compliance:
ASME A112.18.1 / CSA B125.1
NSF 61 - Section 9
NSF 372 (Low Lead Content)
ANSI A117.1 (ADA)



T&S BRASS AND BRONZE WORKS, INC.
 2 Saddleback Cove / P.O. Box 1088
 Travelers Rest, SC 29690

Model No.

B-0221-CC

Item No.

Travelers Rest, SC: 800-476-4103 • Simi Valley, CA: 800-423-0150 • Fax: 864-834-3518 • www.tsbrass.com

ITEM NO.	SALES NO.	DESCRIPTION
1	B-PT	Full Flow Stream Regulator, 55/64-27
2	062X	12" Swing Nozzle
3	009538-45	Swivel Washer
4	011429-45	Swivel Sleeves (2)
5	001074-45	O-Ring
6	014200-45	Star Washer, Anti-Rotation
7	018506-19NS	Blue Button Index, Press-in
8	001638-45NS	Lever Handle (New Style)
9	002711-40NS	Quarter-Turn Eterna Cartridge w/ Spring Check, Handle, Blue Index & Screw, LTC
10	012442-40NS	Quarter-Turn Eterna Cartridge w/ Spring Check, LTC
11	001019-45	Coupling Nut Washer
12	00CC	1/2" NPT Male Inlet Flange
13	000999-45	Brass Lock Washer
14	002954-45	Shank Lock Nut
15	012443-40NS	Quarter-Turn Eterna Cartridge w/ Spring Check, RTC
16	002712-40NS	Quarter-Turn Eterna Cartridge w/ Spring Check, Handle, Red Index & Screw, RTC
17	000925-45	Lab Handle Screw
18	001193-19NS	Red Button Index, Press-in

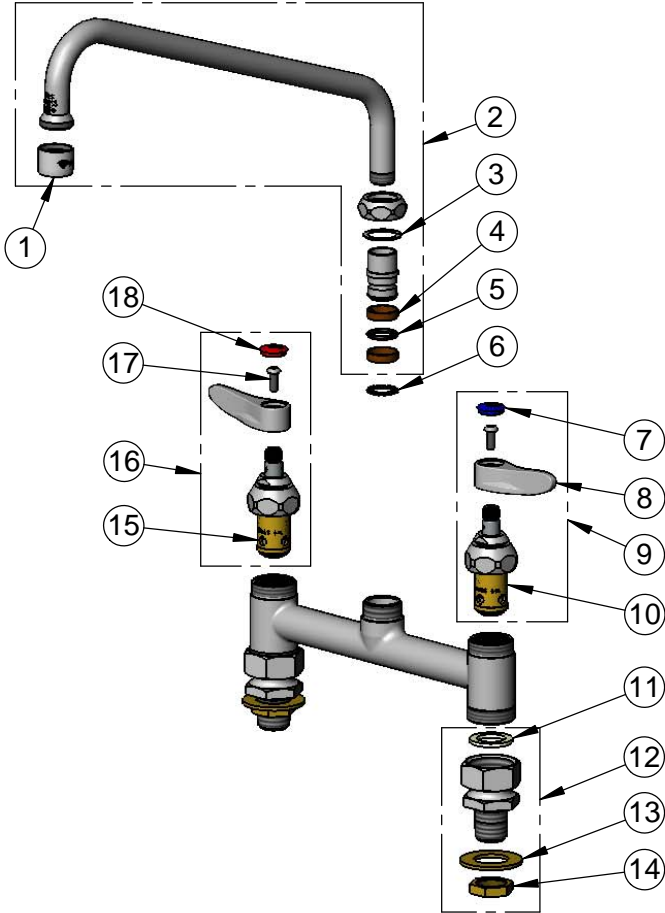

Product Specifications:

8" Deck Mount Mixing Faucet, Quarter-Turn Eterna Cartridges w/ Spring Checks, Lever Handles, 12" Swing Nozzle & 1/2" NPT Male Inlets

Product Compliance:

ASME A112.18.1 / CSA B125.1
 NSF 61 - Section 9
 NSF 372 (Low Lead Content)
 ANSI A117.1 (ADA)