



Faucets and Fittings

5SP-14

TAG:

14" Swing Nozzle

Architect/Engineering Specifications:

14" swing nozzle with polished chrome plated brass tubular body and laminar flow device outlet. Certified to ASME A112.18.1/CSA B125.1, NSF 61-Section 9 and NSF 372.

Job Name _____
 Model Specified _____ Quantity _____
 Variations Specified _____
 Date _____

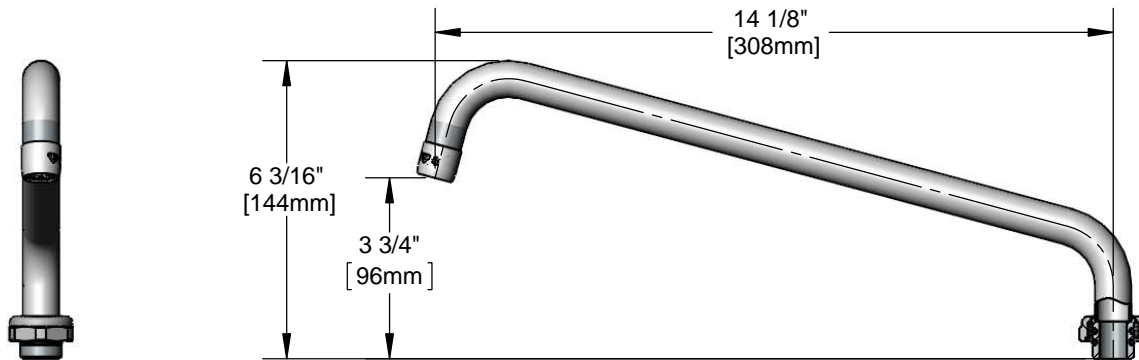
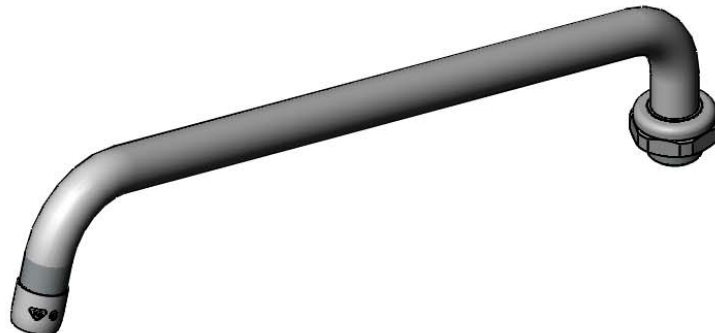

Features & Benefits:

- 14" swing nozzle
- Laminar flow outlet device
- Fits all equip swivel outlet faucets
- Material: Chrome plated brass tubular spout

Product Compliance:

- ASME A112.18.1 / CSA B125.1
- NSF 61 - Section 9
- NSF 372 (Low Lead Content)



Warranty: One Year (Limited)

Performance Data:

- Pressure: 20 - 125 psi
- Temperature: 40 °F - 140 °F
- Flow Rate: 4.5 GPM @ 60 psi



equip Foodservice Accessories



• 2 Saddleback Cove • Travelers Rest, SC 29690
Ph 800-891-4808 • Fax 800-868-0084
www.tsbrass.com

Date: 11/21/16