



Electronic Faucets

EC-3101-LF22

TAG:



Electronic Sensor Faucet

Architect/Engineering Specifications:

Single hole wall mount electronic sensor faucet with polished chrome plated brass body, 4 1/8" rigid gooseneck, 2.2 GPM vandal resistant laminar flow device, AC/DC control module with internal flow control setting switches, temperature control mixing valve with check valves and 18" flexible stainless steel supply hoses with 3/8" compression connections. Certified to ASME A112.18.1/CSA B125.1, NSF 61-Section 9, NSF 372 and UL 1951. Meets ADA ANSI/ICC A117.1 requirements.

Job Name _____
 Model Specified _____ Quantity _____
 Variations Specified _____
 Date _____

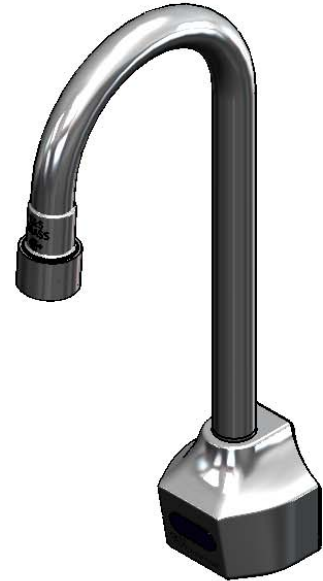
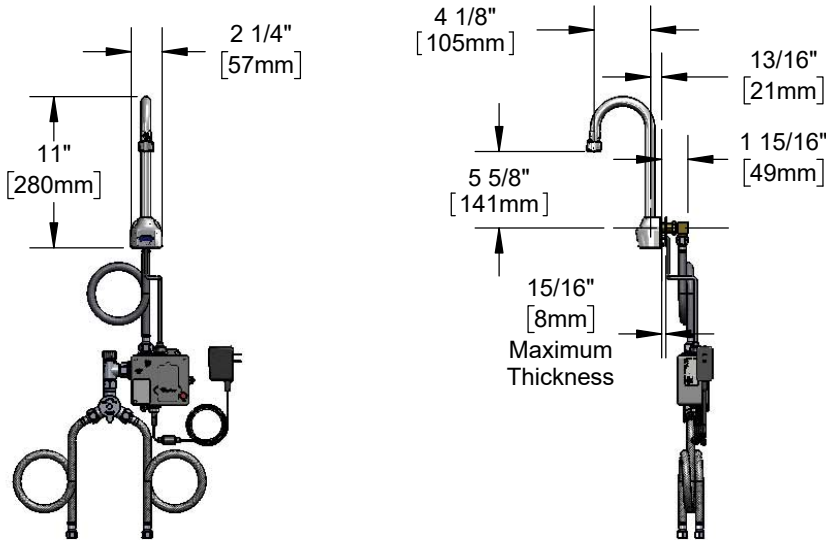

Features & Benefits:

- Single hole wall mount, polished chrome plated brass body
- 4 1/8" rigid gooseneck
- 2.2 GPM vandal resistant laminar flow device, Series 6 (B-0199-06-VRF)
- Water resistant control module w/ internal flow control switches for adjusting auto time out & shut off delay settings
- Optional auto flush feature flows water for 30 seconds after every 12 inactive hours
- Plug in AC transformer or (4) AA battery (DC) power options
- Mechanical temperature mixing valve w/ check valves
- 18" flexible stainless steel supply hoses w/ 3/8" compression inlet connections
- Low battery LED indicator light
- Material: Polished chrome plated brass body and tubular spout

Product Compliance:

- ASME A112.18.1 / CSA B125.1
- NSF 61 - Section 9
- NSF 372 (Low Lead Content)
- ANSI A117.1 (ADA)
- UL 1951



Warranty: Three Year (Limited)



ADA Compliant

Performance Data:

- Pressure: 20 - 125 psi
- Temperature: 40°F - 140°F
- Flow Rate: 2.2 GPM @ 60 psi
- Water Consumption: @10 sec=.37 gal
@15 sec=.55 gal



Optional Outlets (Series 1 / VR Series 6)

GPM	Aerated	Non-Aerated (Laminar)	VR Aerated	VR Non-Aerated (VR Laminar)
0.35	N/A	<input type="checkbox"/> B-0199-01-N035	N/A	<input type="checkbox"/> B-0199-06-N035
0.5	N/A	<input type="checkbox"/> B-0199-01-N05	N/A	<input type="checkbox"/> B-0199-06-N05
1.0	<input type="checkbox"/> B-0199-01-F10	N/A	<input type="checkbox"/> B-0199-06-F10	N/A
1.5	<input type="checkbox"/> B-0199-01-WS	<input type="checkbox"/> B-0199-29	<input type="checkbox"/> B-0199-06-WS	<input type="checkbox"/> B-0199-29VR
2.2	<input type="checkbox"/> B-0199-01	<input type="checkbox"/> B-0199-21	<input type="checkbox"/> B-0199-06	Standard



T&S BRASS AND BRONZE WORKS, INC.



• 2 Saddleback Cove • Travelers Rest, SC 29690
 Ph 800-476-4103 • Fax 864-834-3518
 • Simi Valley, CA • Ph 800-423-0150 • www.tsbrass.com

Date: 09/10/18