



Pre-Rinse Units

B-5120-CR-B8P

TAG:

EasyInstall Workboard Pre-Rinse Unit

Architect/Engineering Specifications:

8" deck mount workboard faucet with polished chrome plated brass body, 18" riser, pull-down activated stainless steel valve unit, insulated grip handle, 1.07 GPM sprayer, ceramic cartridges with check valves, lever handles, 1/2" NPT male inlets and 6" adjustable wall bracket. Certified to ASME A112.18.1/CSA B125.1, NSF 61-Section 9 and NSF 372. 2019 DOE PRSV - Class II compliant.

Job Name _____
 Model Specified _____ Quantity _____
 Variations Specified _____
 Date _____

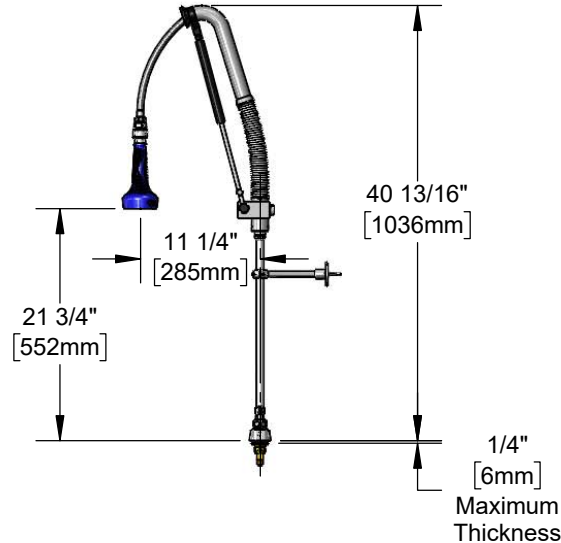
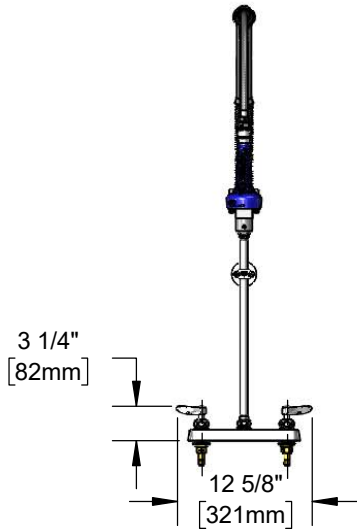

Features & Benefits:

- 8" deck mount workboard faucet w/ polished chrome plated brass body
- 18" EasyInstall riser
- Stainless steel pull-down activated valve unit w/ insulated grip handle blue sprayer
- 1.07 GPM sprayer
- Quarter-turn Cerama cartridges w/ check valves to prevent cross flow of water
- Lever handles w/ color coded indexes
- 1/2" NPT male inlets
- 6" adjustable wall bracket
- Material: Polished chrome plated brass body, riser, stainless steel hose, valve body, spring, and chrome plated metal handles

Product Compliance:

- ASME A112.18.1 / CSA B125.1
- NSF 61 - Section 9
- NSF 372 (Low Lead Content)
- 2019 DOE PRSV - Class II



Warranty: Seven Year (Limited)

- Cerama Cartridge: Lifetime (Limited)

Performance Data:

- Pressure: 20 - 125 psi
- Temperature: 40 °F - 140 °F
- Flow Rate: 1.07 GPM @ 60 psi

Optional Cartridges With Checks

- Quarter-Turn Cerama w/ Check Valve (Standard)
- Quarter-Turn Eterna w/ Spring Check

Optional Handles

- 4" Wrist Action
- Lever (Standard)
- 4-Arm



T&S BRASS AND BRONZE WORKS, INC.



• 2 Saddleback Cove • Travelers Rest, SC 29690
 Ph 800-476-4103 • Fax 864-834-3518
 • Simi Valley, CA • Ph 800-423-0150 • www.tsbrass.com

Date: 03/15/19