



Pre-Rinse Units

B-5120-12-B

TAG:

EasyInstall Workboard Pre-Rinse Unit

Architect/Engineering Specifications:

8" deck mount workboard faucet with polished chrome plated brass body and escutcheon, add-on faucet with compression cartridge with spring check and lever handle, 12" swing nozzle with stream regulator outlet, 24" riser, 44" flexible stainless steel hose with heat resistant handle, 1.15 GPM spray valve, compression cartridges with spring checks, lever handles, 1/2" NPT male inlets, 6" adjustable wall bracket, spray valve holder and overhead spring. Certified to ASME A112.18.1/CSA B125.1, NSF 61-Section 9 & NSF 372. 2019 DOE PRSV - Class II compliant.

Job Name _____
 Model Specified _____ Quantity _____
 Variations Specified _____
 Date _____

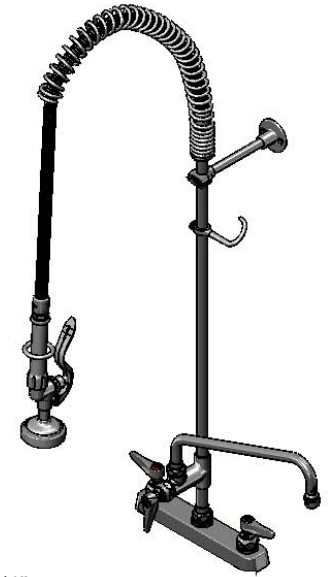
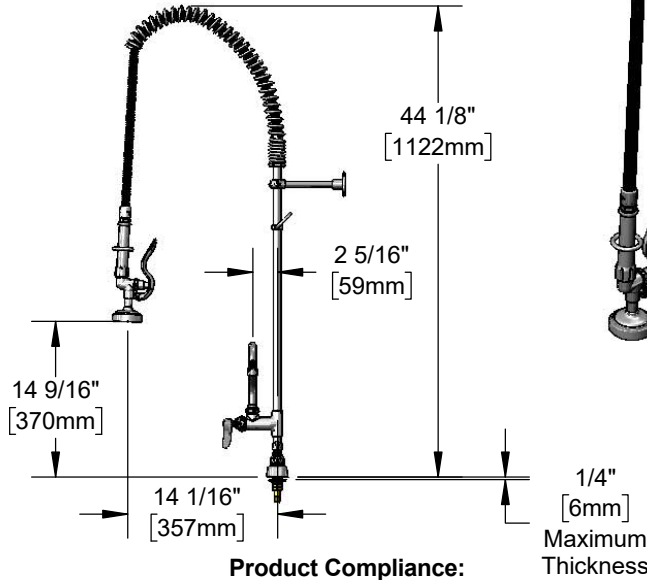
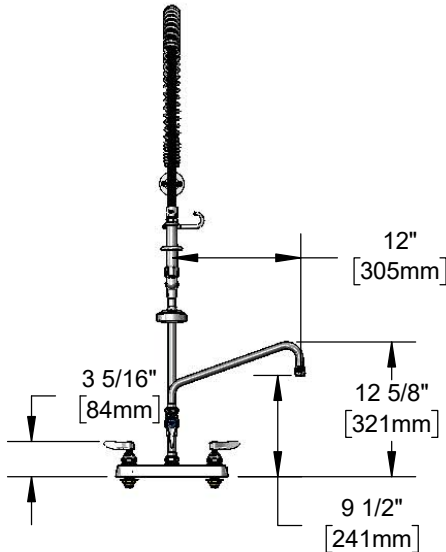

Features & Benefits:

- 8" deck mount workboard faucet w/ polished chrome plated brass body
- EasyInstall add-on faucet w/ polished chrome plated brass body
- 12" swing nozzle w/ stream regulator outlet, Series 1
- 24" rigid riser
- 44" flexible stainless steel hose w/ heat resistant gray handle and hold down ring
- 1.15 GPM spray valve
- Quarter-turn Eterna compression cartridges with spring checks to prevent water cross flow
- Lever handles w/ color coded indexes
- 1/2" NPT male inlets
- Tailpiece and nut for 1/4" NPT connection
- 6" adjustable wall bracket
- Material: Polished chrome plated brass body, tubular nozzle, add-on faucet body, riser, escutcheon & spray valve body, stainless steel hose and chrome plated metal handles

Product Compliance:

- ASME A112.18.1 / CSA B125.1
- NSF 61 - Section 9
- NSF 372 (Low Lead Content)
- 2019 DOE PRSV - Class II



Warranty: Three Year (Limited)

Performance Data:

- Pressure: 20 - 125 psi
- Temperature: 40 °F - 140 °F
- Flow Rate:
 - Spray Valve: 1.15 GPM @ 60 psi
 - Add-On Faucet: 7.56 GPM @ 60 psi

Optional Add-On Faucet Outlets (Series 1 / VR Series 6)

GPM	Aerated	VR Aerated (VR Laminar)
1.0	<input type="checkbox"/> B-0199-01-F10	<input type="checkbox"/> B-0199-06-F10
1.5	<input type="checkbox"/> B-0199-01-WS	<input type="checkbox"/> B-0199-06-WS
2.2	<input type="checkbox"/> B-0199-01	<input type="checkbox"/> B-0199-06

Optional Cartridges With Checks

- Quarter-Turn Cerama w/ Check Valve
- Quarter-Turn Eterna w/ Spring Check (Standard)

Optional Pre-Rinse Spray Valves

- B-0107 (1.15 GPM) (Standard)
- B-0107-C (0.65 GPM)
- B-0107-J (1.07 GPM)
- B-0108 (1.48 GPM)
- B-0108-C (0.65 GPM)

Optional Handles

- 4" Wrist Action
- Lever (Standard)
- 4-Arm



T&S BRASS AND BRONZE WORKS, INC.



• 2 Saddleback Cove • Travelers Rest, SC 29690
 Ph 800-476-4103 • Fax 864-834-3518
 • Simi Valley, CA • Ph 800-423-0150 • www.tsbrass.com

Date: 10/15/18