



Medical and Lavatory Faucets

B-2990-VF05

EasyInstall

Concealed Widespread Lavatory Faucet

TAG:

Architect/Engineering Specifications:

8" concealed deck mount mixing faucet with forged brass body, polished chrome plated cast spout with 0.5 GPM vandal resistant non-aerated spray device, compression cartridges with spring checks, lever handles, vandal resistant screws, polished chrome plated escutcheons and 1/2" NPT male inlets with coupling nuts. Certified to ASME A112.18.1/CSA B125.1, NSF 61-Section 9, NSF 372. Meets ADA ANSI/ICC A117.1 requirements.

Job Name _____
 Model Specified _____ Quantity _____
 Variations Specified _____
 Date _____

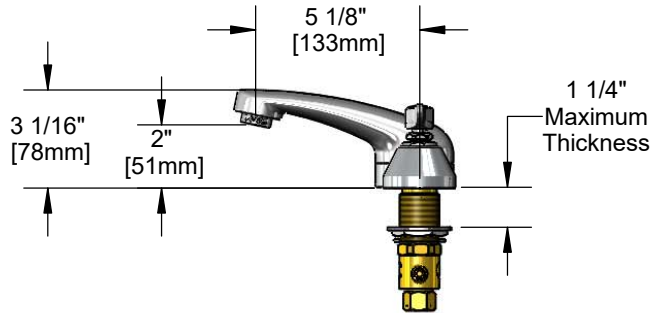
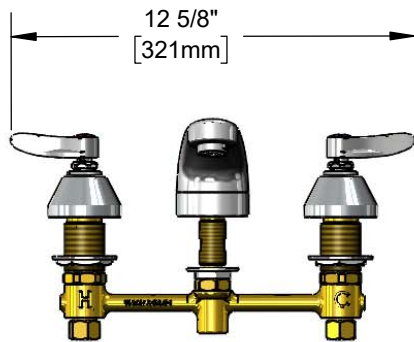

Features & Benefits:

- 8" EasyInstall concealed deck mount mixing faucet w/ forged brass body
- Polished chrome plated brass cast spout
- 0.5 GPM vandal resistant non-aerated spray device, Series 8 (B-0199-08-N05)
- Quarter-turn Eterna compression cartridges w/ spring checks to prevent cross flow of water
- Lever handles w/ color coded indexes
- Vandal resistant screws
- 1/2" NPT male inlets w/ coupling nuts
- Material: Forged brass body, chrome plated metal handles and escutcheons & polished chrome plated brass tubular spout

Product Compliance:

- ASME A112.18.1 / CSA B125.1
- NSF 61 - Section 9
- NSF 372 (Low Lead Content)
- ANSI A117.1 (ADA)



Warranty: One Year (Limited)

Performance Data:

- Pressure: 20 - 125 psi
- Temperature: 40 °F - 140 °F
- Flow Rate: 0.5 GPM @ 60 psi



ADA Compliant

Optional Outlets (Series 3 / VR Series 8)

GPM	Aerated	Non-Aerated (Laminar)	VR Aerated	VR Non-Aerated (VR Laminar)
0.35	N/A	<input type="checkbox"/> B-0199-03-N035	N/A	<input type="checkbox"/> B-0199-08-N035
0.5	N/A	<input type="checkbox"/> B-0199-03-N05	N/A	Standard
1.0	N/A	N/A	N/A	<input type="checkbox"/> B-0199-08-LF10
1.2	<input type="checkbox"/> B-0199-03-F12	N/A	<input type="checkbox"/> B-0199-08-F12	N/A
1.5	<input type="checkbox"/> B-0199-03-WS	N/A	<input type="checkbox"/> B-0199-08-WS	<input type="checkbox"/> B-0199-08-LF15
2.2	<input type="checkbox"/> B-0199-03	<input type="checkbox"/> B-0199-26	<input type="checkbox"/> B-0199-08	<input type="checkbox"/> B-0199-28

Optional Handles

- 4" Wrist Action
- Lever (Standard)
- 4-Arm

Optional Cartridges

- Quarter-Turn Cerama w/ Check Valve
- Quarter-Turn Eterna w/ Spring Check (Standard)
- Push Button Metering
- Pivot Action Metering
- Wrist Action Metering



T&S BRASS AND BRONZE WORKS, INC.



• 2 Saddleback Cove • Travelers Rest, SC 29690
 Ph 800-476-4103 • Fax 864-834-3518
 • Simi Valley, CA • Ph 800-423-0150 • www.tsbrass.com

Date: 12/14/15