



Architect/Engineering Specifications:

Add-on faucet with polished chrome plated brass body, 3/8" NPT female outlet, 6" swing nozzle with stream regulator outlet, compression cartridge with spring check, lever handle and 3/8" NPT male inlet. Certified to ASME A112.18.1/CSA B125.1, NSF 61-Section 9 and NSF 372. Meets ADA ANSI/ICC A117.1 requirements.

Job Name _____

Model Specified _____ Quantity _____

Variations Specified _____

Date _____

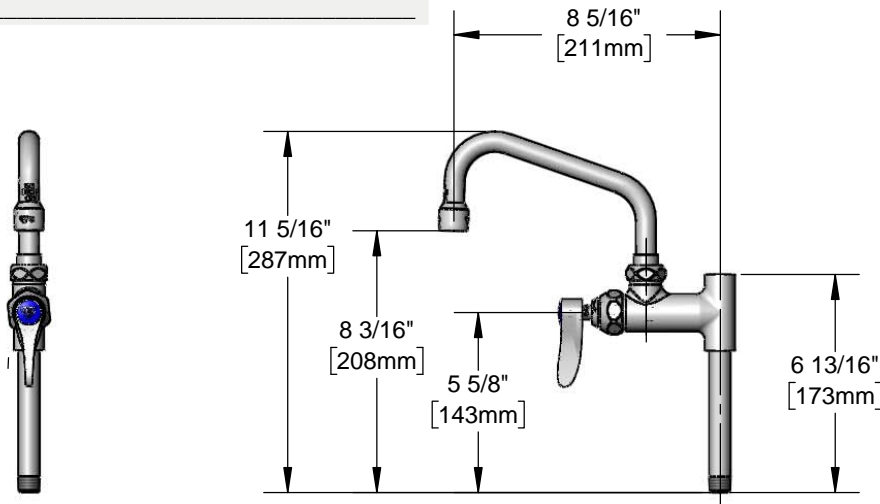

Features & Benefits:

- Add-on faucet w/ polished chrome plated brass body
- 3/8" NPT female outlet
- 6" swing nozzle
- Stream regulator outlet, Series 1
- Quarter-turn Eterna compression cartridge w/ spring check
- Lever handle
- 5" nipple w/ 3/8" NPT male inlet
- Material: Polished chrome plated brass body, tubular nozzle & nipple and chrome plated metal handle

Product Compliance:

- ASME A112.18.1 / CSA B125.1
- NSF 61 - Section 9
- NSF 372 (Low Lead Content)
- ANSI A117.1 (ADA)



Warranty: One Year (Limited)

Performance Data:

- Pressure: 20 - 125 psi
- Temperature: 40 °F - 140 °F
- Flow Rate: 9.73 GPM @ 60 psi



Optional Add-On Faucet Outlets (Series 1 / VR Series 6)

GPM	Aerated	VR Aerated
1.0	<input type="checkbox"/> B-0199-01-F10	<input type="checkbox"/> B-0199-06-F10
1.5	<input type="checkbox"/> B-0199-01-WS	<input type="checkbox"/> B-0199-06-WS
2.2	<input type="checkbox"/> B-0199-01	<input type="checkbox"/> B-0199-06

Optional Handles

- 4" Wrist Action
- Lever (Standard)
- 4-Arm

Optional Cartridges With Checks

- Quarter-Turn Cerama w/ Check Valve
- Quarter-Turn Eterna w/ Spring Check (Standard)

