



T&S BRASS AND BRONZE WORKS, INC.

2 Saddleback Cove / P.O. Box 1088
Travelers Rest, SC 29690

Model No.

B-2851-L

Item No.

Travelers Rest, SC: 800-476-4103 • Simi Valley, CA: 800-423-0150 • Fax: 864-834-3518 • www.tsbrass.com

This Space for Architect/Engineer Approval

Job Name _____ Date _____

Model Specified _____ Quantity _____

Customer/Wholesaler _____

Contractor _____

Architect/Engineer _____



ADA Compliant

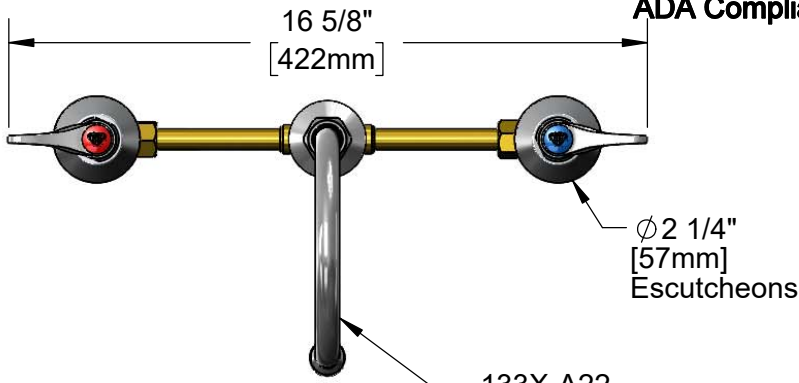

133X-A22 Swivel Gooseneck w/ 2.2 GPM Aerator. Rigid Conversion Requires 014200-45 Lock Washer (Included)

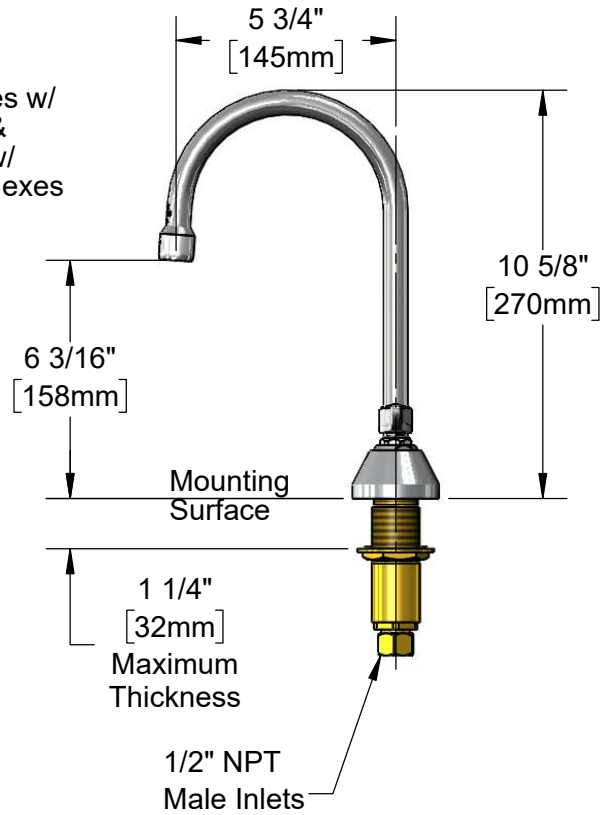
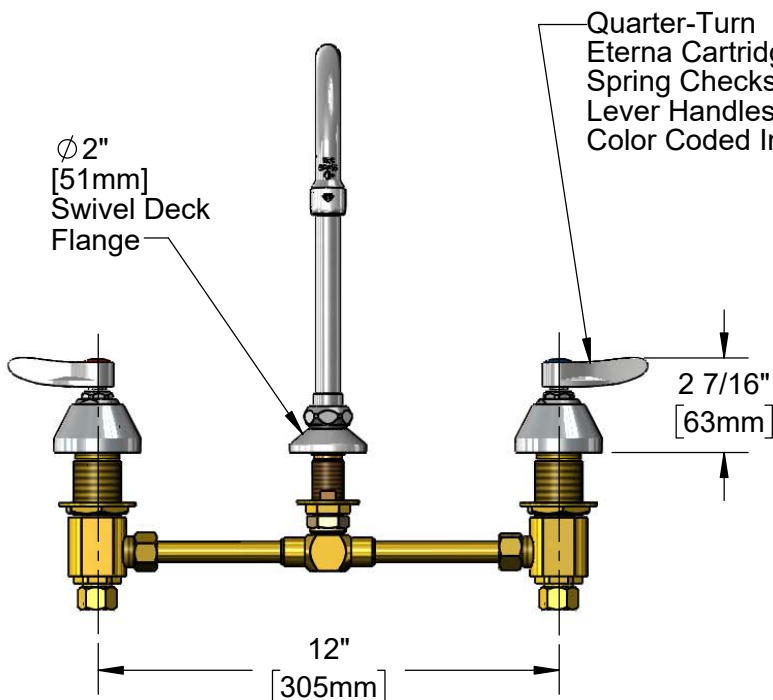
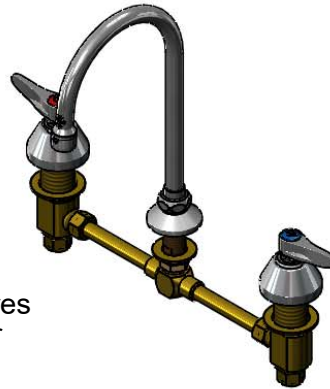

Rough-In Requirement:
Center Shank: Ø 1" [25mm] Mounting Hole
Hot/Cold Side: Ø 1 1/2" [38mm] Mounting Holes

Product Specifications:

12" Concealed Widespread Mixing Faucet, Lever Handles, Quarter-Turn Eterna Cartridges w/ Spring Checks, 5 3/4" Rigid/Swivel Gooseneck w/ 2.2 GPM Aerator and 1/2" NPT Male Inlets w/ Coupling Nuts

Product Compliance:

ASME A112.18.1 / CSA B125.1
NSF 61 - Section 9
NSF 372 (Low Lead Content)
ANSI A117.1 (ADA)



T&S BRASS AND BRONZE WORKS, INC.

2 Saddleback Cove / P.O. Box 1088
Travelers Rest, SC 29690

Model No.

B-2851-L

Item No.

Travelers Rest, SC: 800-476-4103 • Simi Valley, CA: 800-423-0150 • Fax: 864-834-3518 • www.tsbrass.com

ITEM NO.	SALES NO.	DESCRIPTION
1	B-0199-01	2.2 GPM Aerator, 55/64-27 UN Female
2	133X-A22	5 3/4" Swivel Gooseneck w/ 2.2 GPM Aerator
3	009538-45	Swivel Washer
4	001074-45	O-Ring
5	011429-45	Swivel Sleeves (2)
6	014200-45	Star Washer, Anti-Rotation
7	000999-45	Brass Lock Washer
8	002954-45	Shank Lock Nut
9	018506-19NS	Blue Button Index, Press-in
10	000925-45	Lab Handle Screw
11	001636-45NS	Lever Handle, Blue Index & Screw
12	001257-40NS	Bell Escutcheon
13	006477-40NS	CWS Quarter-Turn Eterna Cartridge w/ Spring Check, LTC
14	000958-20	Coupling Nut
15	006478-40NS	CWS Quarter-Turn Eterna Cartridge w/ Spring Check, RTC
16	001638-45NS	Lever Handle (New Style)
17	001193-19NS	Red Button Index, Press-in
18	001637-45NS	Lever Handle, Red Index & Screw

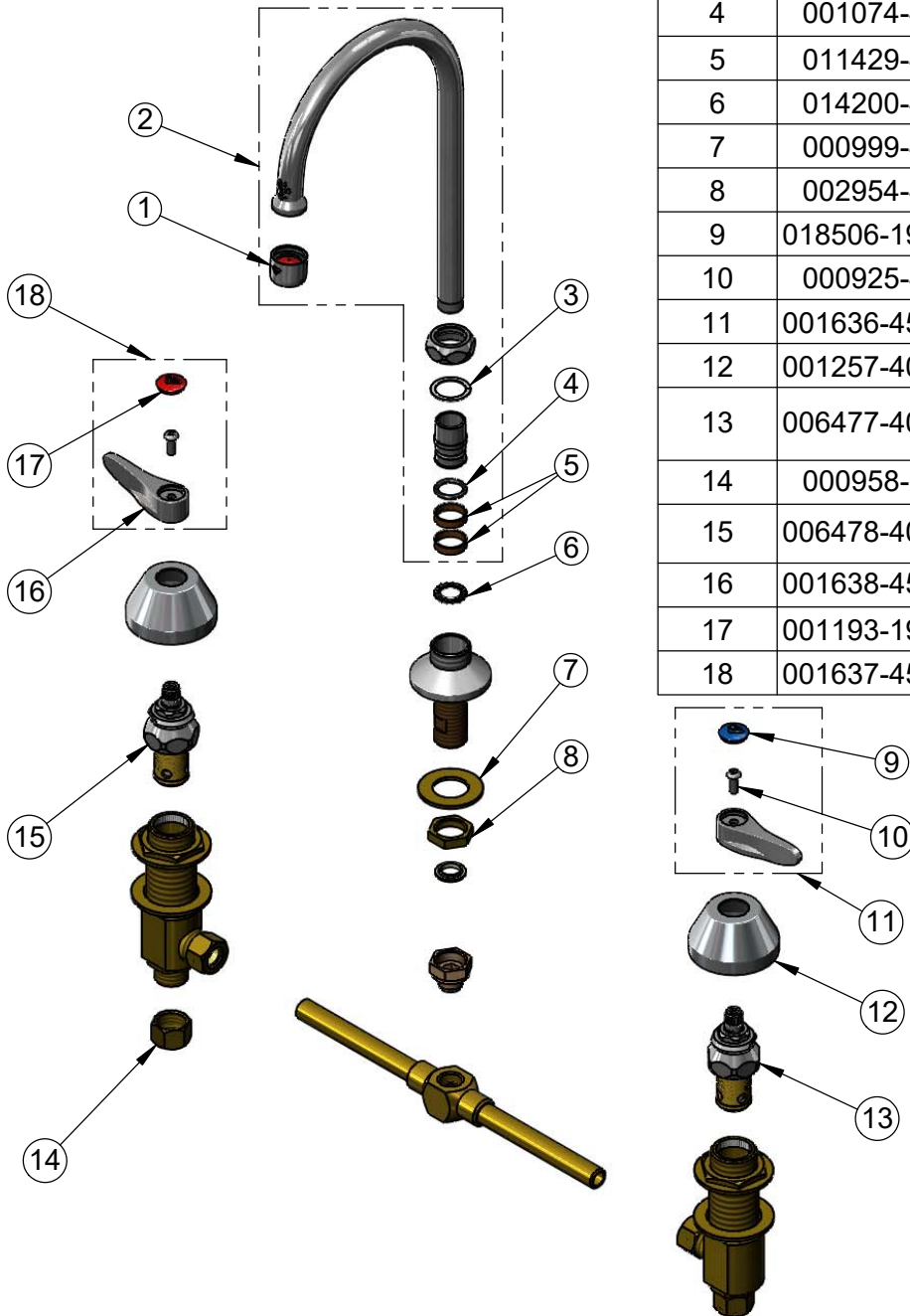

Product Specifications:

12" Concealed Widespread Mixing Faucet, Lever Handles, Quarter-Turn Eterna Cartridges w/ Spring Checks, 5 3/4" Rigid/Swivel Gooseneck w/ 2.2 GPM Aerator and 1/2" NPT Male Inlets w/ Coupling Nuts

Product Compliance:

ASME A112.18.1 / CSA B125.1
NSF 61 - Section 9
NSF 372 (Low Lead Content)
ANSI A117.1 (ADA)