



T&S BRASS AND BRONZE WORKS, INC.

2 Saddleback Cove / P.O. Box 1088
Travelers Rest, SC 29690

Model No.

B-0507-03

Item No.

Travelers Rest, SC: 800-476-4103 • Simi Valley, CA: 800-423-0150 • Fax: 864-834-3518 • www.tsbrass.com

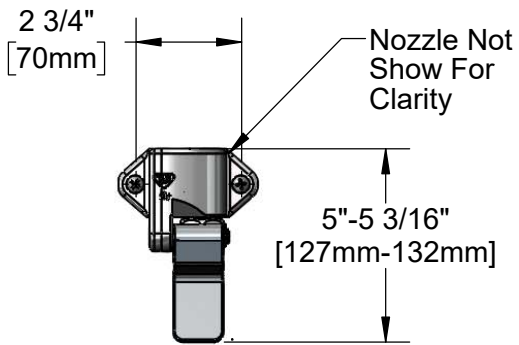

This Space for Architect/Engineer Approval

Job Name _____ Date _____

Model Specified _____ Quantity _____

Customer/Wholesaler _____

Contractor _____

Architect/Engineer _____

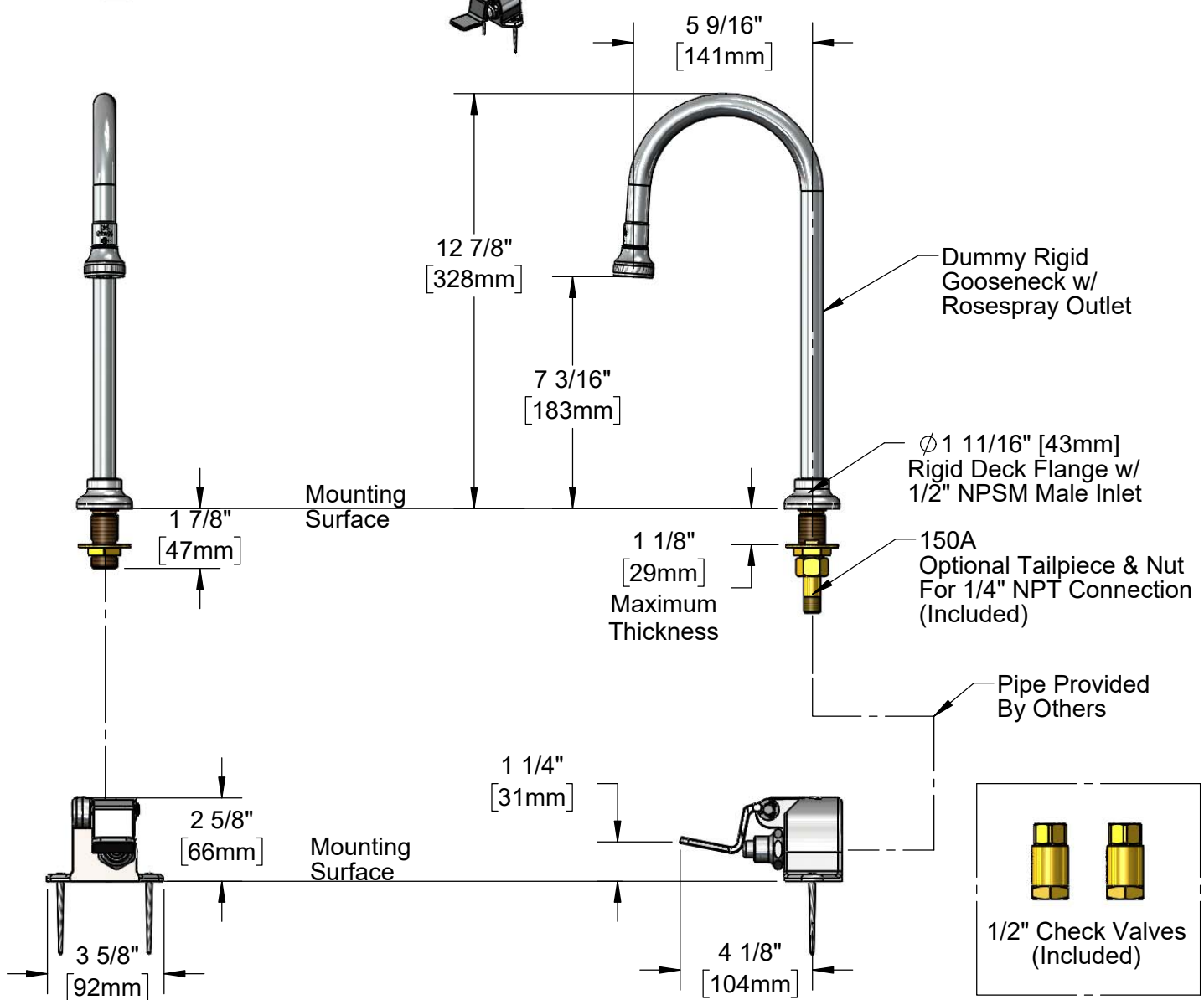

Product Specifications:
 Floor-Mounted Single Pedal Valve w/ Dummy Rigid Gooseneck and Rosespray Outlet

Product Compliance:
 ASME A112.18.1 / CSA B125.1
 NSF 61 - Section 9
 NSF 372 (Low Lead Content)



T&S BRASS AND BRONZE WORKS, INC.
 2 Saddleback Cove / P.O. Box 1088
 Travelers Rest, SC 29690

Model No.
B-0507-03

Item No.

Travelers Rest, SC: 800-476-4103 • Simi Valley, CA: 800-423-0150 • Fax: 864-834-3518 • www.tsbrass.com

ITEM NO.	SALES NO.	DESCRIPTION
1	B-0103	Rosespray Outlet w/ Washer
2	001043-45	Washer
3	016847-40	EasyInstall CWS Rigid Center Shank
4	000999-45	Brass Lock Washer
5	002954-45	Shank Lock Nut
6	150A	1/4" NPT Tailpiece
7	B-0507	Single Pedal Valve
8	B-CVV1-2	1/2" Check Valve

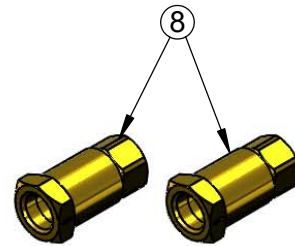
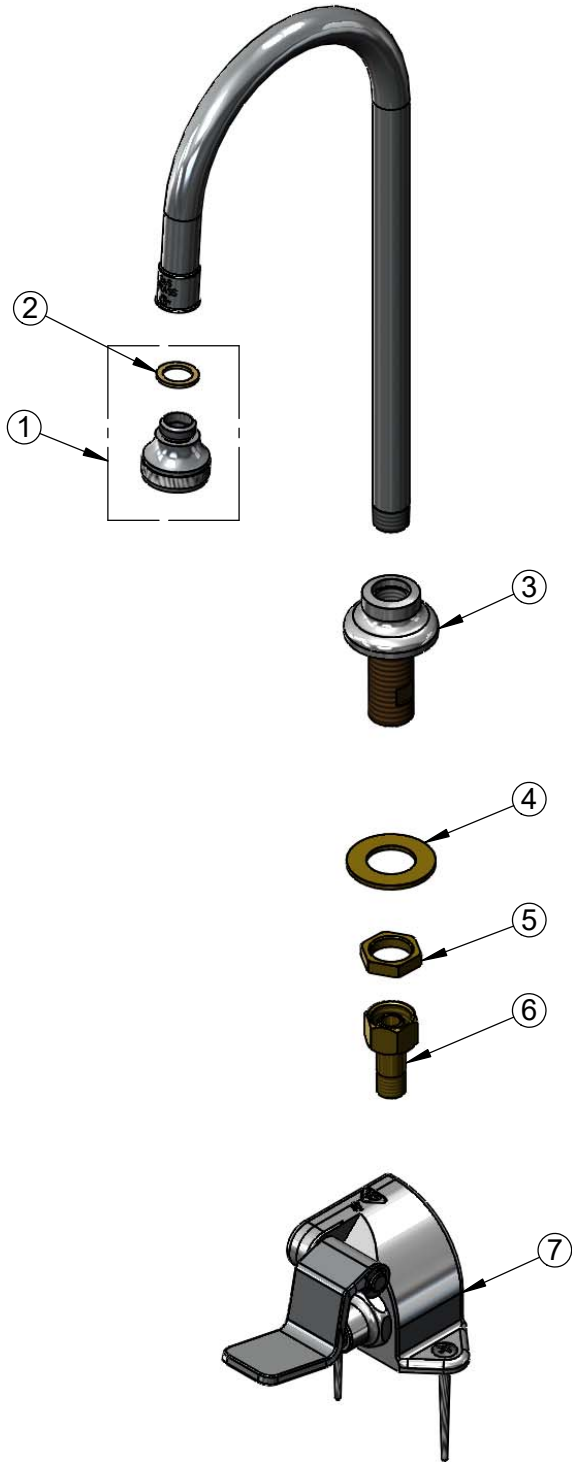

Product Specifications:
 Floor-Mounted Single Pedal Valve w/ Dummy Rigid Gooseneck and
 Rosespray Outlet

Product Compliance:
 ASME A112.18.1 / CSA B125.1
 NSF 61 - Section 9
 NSF 372 (Low Lead Content)